



**HAL**  
open science

## **STAMS : New tools for monitoring flooded and nonflooded mine shaft**

Marwan Al Heib, O. Alvarez, M. Bedford, F.M. Fernandez, A. Jardon, F. Hadj Hassan, Stéphane Lafortune, Z. Lubosik, C. Satterley, K. Siever, et al.

### ► **To cite this version:**

Marwan Al Heib, O. Alvarez, M. Bedford, F.M. Fernandez, A. Jardon, et al.. STAMS : New tools for monitoring flooded and nonflooded mine shaft. 12. International conference on mine closure (Mine CLosure 2018), Sep 2018, Leipzig, Germany. pp.483-496. ineris-01960311

**HAL Id: ineris-01960311**

**<https://ineris.hal.science/ineris-01960311>**

Submitted on 19 Dec 2018

**HAL** is a multi-disciplinary open access archive for the deposit and dissemination of scientific research documents, whether they are published or not. The documents may come from teaching and research institutions in France or abroad, or from public or private research centers.

L'archive ouverte pluridisciplinaire **HAL**, est destinée au dépôt et à la diffusion de documents scientifiques de niveau recherche, publiés ou non, émanant des établissements d'enseignement et de recherche français ou étrangers, des laboratoires publics ou privés.

# STAMS<sup>7</sup>: New Tools for Monitoring Flooded and Non-flooded Mine Shaft

**M Al Heib** *Ineris, France*

**O Alvarez** *grupo hunosa, Spain*

**J Alvarez** *Universidad Carlos III, Madrid, Spain*

**M Bedford** *University of Exeter, GB*

**FM Fernandez** *grupo hunosa, Spain*

**A Jardon** *Universidad Carlos III, Madrid, Spain*

**F Hadj Hassan** *Mines Paris, France*

**S Lafortune** *Ineris, France*

**Z Lubosik** *GIG, Poland*

**C Satterley** *The Coal Authority, UK*

**K Siever** *dmt-Group, Germany*

**B Schoen** *dmt-Group, Germany*

**R Terroba** *grupo hunosa, Spain*

**A Werna** *GIG, Poland*

**A Winkler** *SRK, Poland*

## Abstract

*In European coalmines, there are many unequipped, abandoned shafts (in Poland, Germany, France, Spain, UK and other countries) in which the long-term stability is a cause of concern. The need for continuous assessment and monitoring of the stability of abandoned shafts present a real challenge particularly for deep shafts. The European STAMS research project (Long-term STability Assessment and Monitoring of flooded Shafts), subsidized by the Research Fund for Coal and Steel programme (RFCS), is addressing this issue. The objective of the STAMS project is to implement Periodic Inspection Modules, and to design permanently installed monitoring systems, to achieve periodic and long-term continuous monitoring and condition assessment of flooded mine shafts. The project proposes solutions to monitor and to assess the stability and the conditions of flooded shafts, including the non-flooded portions of partially flooded shafts, for long periods of time. The Multi-functional Monitoring Module is able to make periodic measurements in order to assess the stability of a flooded shaft. The Ultrasonic Inspection Module allows the detection of lining deformations with high precision between periodic inspections of shafts. In addition to monitoring, a modelling approach has been developed to assess the long-term stability of shafts during and after flooding by coupling the hydro-mechanical behaviour with the chemical reactions which occur between the mine water and the shaft lining components. A database of the flooded shafts has been established. Laboratory and trials tests are carried out by the partners of the project to check the tools and to test them under real conditions. This paper presents and describes the developed modules and the first obtained results.*

**Keywords:** *Shaft, lining, flooded, inspection, damaged, monitoring*

---

<sup>7</sup>Partners of STAMS (<http://stams-rfcs.eu/>): INERIS and ARMINES (France), UK Coal Authority, University of Exeter (UK), DMT (Germany), GIG, PGG and SRK (Poland), Hunosa and UC3M (Spain).

# 1 Project rationale and objectives

In European coalmines, there are many unequipped shafts, which are mainly upcast ventilation (exhaust) shafts and, less often, intake shafts (Lecomte et al., 2012). In the Polish hard coal mining industry alone there are around 50 active shafts of this kind (Bock, 2014). Complementary to this, in France and the UK, there are more than 150,000 recorded mine entries, which may require inspection. The impacts are significant and vary from local scale (e.g. collapse) to mesoscale, where the extensive hydraulic interconnectivity of mine workings must be taken as a fact of life (Figure 5). Most European countries have problems with and are trying to deal with these issues.

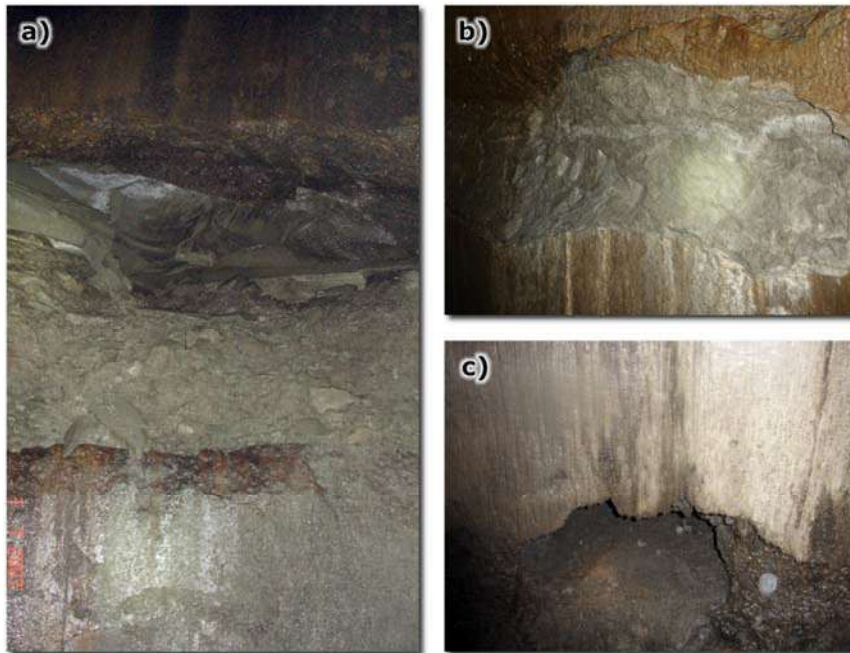

**Figure 5** Examples of deep lining damage (Bock, 2014), a – very wide and deep lining loss throughout the entire thickness, with rocks visible behind the former lining b – deep lining damage (to a depth of approximately 20 cm), c – wide and deep lining damage

Depending on the context, the concrete lining of shafts may require periodic inspection and continuous monitoring to assess its condition and stability. However, in most ventilation shafts serving active mines, and in pumping stations using submersible pumps, there is no personnel access equipment installed. This makes it practically impossible to perform direct inspections on the lining of even the non-flooded portions of the shafts, because there is no safe means of access. In Poland, there are currently 30 active shafts which are partially flooded, whose lining must be evaluated every five years according to legislation. However, given the technical limitations (lack of proper equipment), even when limited inspections are possible, they are carried out only on the upper, non-flooded shaft sections. It should be emphasized that in such cases the full assessment of shaft lining stability is impossible using currently available techniques. Similarly, in the UK, there are an estimated 1,000 – 5,000 flooded open coal mine shafts and a legal obligation to ensure their safety (Whitworth, 2002).

Although existing technologies used in other industries (e.g. oil and gas borehole logging) can work at depths of 1500 m, as required for this application, monitoring flooded mine shafts poses unique challenges that are not addressed in other industries.

Another particularly big issue is the necessity to lower an instrument to the proper depth before starting the appropriate underwater inspection. That is because the water level in many flooded shafts is located at a depth of several hundreds of meters below the surface. To avoid entanglement with shaft infrastructure in the non-flooded section of the shaft, and to allow a single module to be used both above and below the water surface, monitoring and inspection modules must incorporate some inspection capability above the

water level. This requires a unique combination of existing dry shaft inspection techniques and technologies relevant to the underwater environment.

The objective of the project is to develop technologies to assess the condition of shafts that are partially or completely flooded now, and of those that will be flooded in the future. Such an assessment is essential in order to take action to avoid the detrimental effect associated with the deterioration of disused mineshafts. The need for continuous assessment and monitoring of the stability of abandoned shafts will increase in the following years. The project contributes to the future urban development of coalmine districts in European coalfields.

## 2 Flooded shafts characterization

In order to better understand the monitoring requirements, 23 Polish coalmine shafts were analysed (Figure 6). The data obtained shows that, in most cases, the depth of the shafts is between 500 and 700 m. Only two shafts were deeper, but even then, the depth was less than 800 m. The water level in many flooded shafts is located at a depth of several hundreds of meters below the surface. The diameter of shafts of the most cases (69%), is between 4 and 6 m. The practical implications of the data obtained is that the inspection devices should be able to operate in shafts with a diameter between 4 and 8 m. The collected data shows that significant access limitations result from the size of the access opening. The minimal values (0.60 - 0.75 m) occur in 6 of the 23 shafts. However, the size limitations have a larger impact on the dimensions of the inspection modules. In some cases, it should be assumed that a reconstruction of the shaft opening may be required. The most typical lining in the analysed shafts is concrete with thickness between 0.5 and 0.75 m.

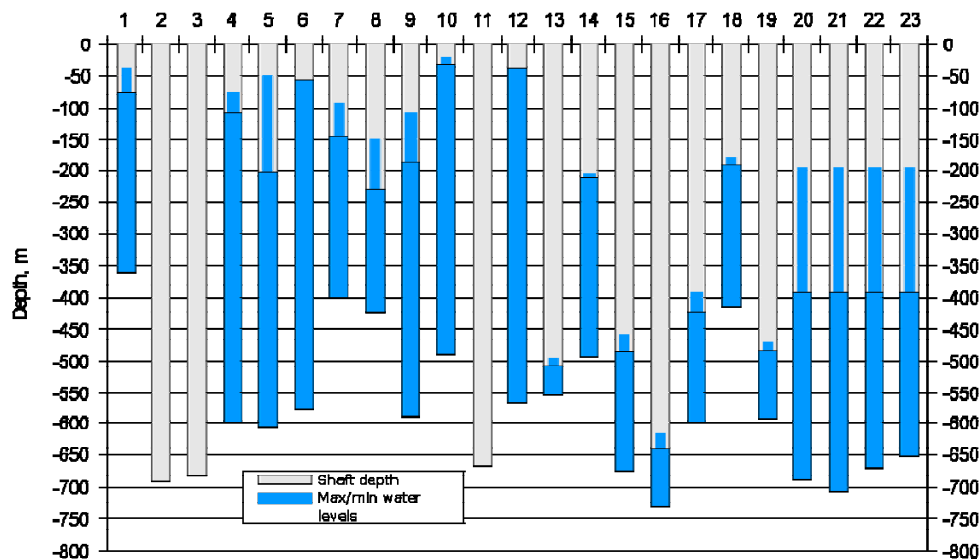

Figure 6 Range of Shaft Depths in Analysed Shafts

## 3 Periodic inspection system

### 3.1 Overview

A periodic inspection system has been developed to evaluate the state of flooded shafts. The periodic shaft inspection system of the STAMS project comprises two different periodic measurement modules (PMMs)- the **U**ltrasonic **I**nspection **M**odule (UIM) and the **M**ultifunctional **M**easurement **M**odule (MMM) - and the **R**eference **P**oint **I**nstallation **M**odule (RPIM) which is used for fitting reference points that will subsequently be detected by the inspection modules (Figure 7). The PMMs have been designed and developed to withstand an external water pressure of 150 bar which corresponds to a depth of 1500 m.

In order to minimize development cost and equipment cost for the end user, a decision was made to use certain common sub-modules as illustrated in *Figure 7* and described in the following paragraphs.

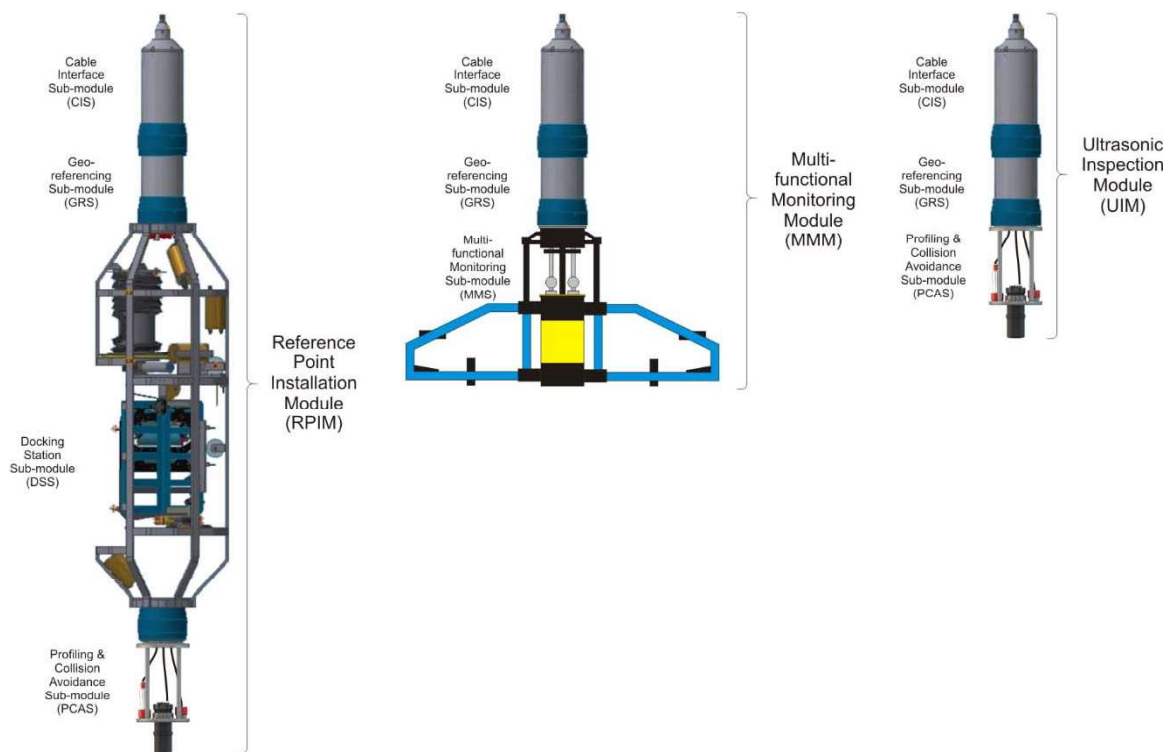

**Figure 7 Periodic measurement modules (PMMs)- the Ultrasonic Inspection Module (UIM) and the Multifunctional Measurement Module (MMM)**

The Geo-referencing Sub-module (GRS) contains an inertial measurement unit (IMU). This allows the orientation of a PMM with respect to north and its position within the cross-section of the shaft to be determined, so that unintentional motion during winching operations can be corrected. Sensing of the fixed reference points is also an important element of geo-referencing but this is achieved using the same sonar instruments that are used to measure the shaft's profile which is external to the GRS. The Cable Interface Sub-module (CIS) provides a power supply and communication facilities, plus the mechanical interface between the module and the wireline. The PCAS (Profiling and Collision Avoidance Sub-module) provides the Obstacle detection, above the water level is achieved using a downwards looking CCTV camera while this functionality is achieved below the water level using a sonar altimeter. The PCAS is also used in the Fixed Reference Point Installation Module.

### 3.2 Multi Monitoring Module (MMM)

The MMM provides a suite of instruments, mostly for conducting tests on the properties of the water in flooded shafts and carrying out microscopic inspections, but with the addition of some rudimentary ultrasonic capability. The capability of the MMM is extended by the addition of a full scanning sonar capability, including both profiling and possibly also imaging. It was considered that this change would be much more cost-effective, for those users who require a full shaft characterisation including water sampling and ultrasonic surveying, than if two separate PMMs had to be used. The Multi-Functional Monitoring Module (MMM) has the following components:

- Cameras with 1/3 in CCD Sensor, wide angle and low underwater distortion and light sources working to the depth of 6000 m (producer Deep Sea);
- Transmission and power modules compatible with Fixed RPIM;
- Car trailer and winch components will be used to inspection zone of the flooded shaft.

### 3.3 Ultrasonic Inspection Module (UIM)

The Ultrasonic Inspection Module (UIM) is one of two Periodic Measurement Modules (PMMs) that have been developed in the project. Its purpose is to carry out ultrasonic inspections of the lining of flooded portions of shafts where visual inspection would not be possible due to the turbidity of the shaft water. In particular, the output of a scanning exercise is a series of shaft profiles, from which a 3D model can be built, that can be compared with the output of previous scans to detect changes which could indicate damage to the lining and, hence, possible imminent collapse.

Ultrasonic scanners (sonars) take one of two forms as illustrated in **Fehler! Verweisquelle konnte nicht gefunden werden.:** (1) A profiling scanner has a narrow sonar beam which intersects with the surface being scanned at right angles. It records either the first or the strongest return signal. Multiple measurements are made by use of mechanical scanning – through 360 degrees in the case of a shaft – and when this is combined with the vertical movement of the unit down the shaft by winching, a geometrically accurate 3D model of the shaft is obtained.

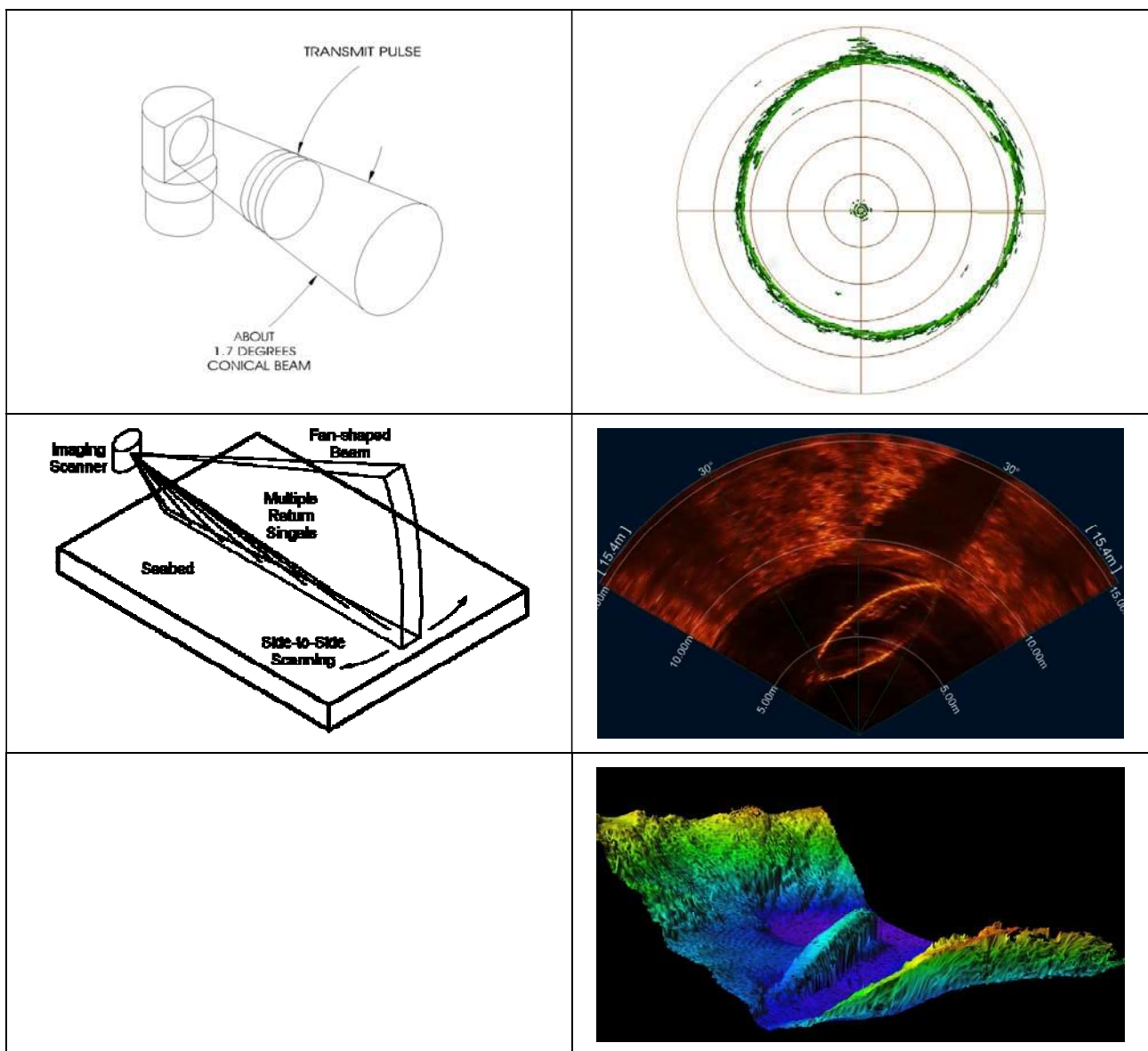

Figure 4 Comparison between Profiling and Imaging Sonar Top-left: Profiler beam characteristics, Top-right: Typical profiler output (mine shaft), Middle-left: Imager beam characteristics for typical seabed application, Middle-right: typical imager output (ship on seabed), Bottom-right: Waterfall display generated from profiling output (feature on seabed)

(2) An imaging scanner has a broad fan-shaped beam which intersects the surface being scanned at an oblique angle. Multiple return signals are recorded, corresponding to different distances from the scanner. Again, rotational scanning occurs and, since the amplitude of the return signals provides density information about the target, this allows an image to be created that is similar to a visual image.

In this application, it was initially considered that a novel combination of the two types of sonar would provide accurate measurements from the profiler while the imager would assist in the identification of features. It was decided early in the project, however, that a major differentiator between the two PMMs should be one of cost, allowing end users to choose either a low-cost unit with basic facilities (the UIM) or a higher-cost unit with a broader range of facilities (the MMM), depending on their budget. For this reason, it was decided to include only a profiling sonar in the UIM but to allow the display of a software generated waterfall display (see **Fehler! Verweisquelle konnte nicht gefunden werden.**) which will offer many of the perceived benefits of an imaging sonar but without the incremental cost of the additional hardware. The sub-module that achieves the UIM's main purpose of measuring the shaft's profile is the Profiling and Collision Avoidance Sub-module (PCAS). As the bottom-most sub-module in the UIM, the PCAS also includes instruments for detecting obstructions below the UIM which could pose a collision risk. All the instruments in the PCAS are off-the-shelf instruments. The profiling sonar, selected from candidate instruments from four manufacturers, is the Tritech Super Seaking Profiler.

### 3.4 Reference Points Installation Module (RPIM)

The main function of the Reference Point Installation Module (RPIM) is the installation of the so-called Reference Points (RP) along the shaft wall. The Reference Points will serve to correct the estimated position of the sensing modules: as these RPs are placed in known positions, a map will be created through which the modules can correct their position by obtaining their relative position with respect to the Points of Reference. Reference, applying an algorithm of SLAM (Simultaneous Localization and Mapping), similarly to (Gomez et al., 2004, Lefebvre et al., 2009). The RPIM will be hung along the shaft through the common cable to the rest of the modules, through which it also transmits information. For the installation of the points, a submarine mobile robot (ROV, for its acronym in English) is used, which carries with it the tool for fixing reference points. During the descent, the ROV will go inside a cage (Docking Station Sub-module, DSS), which will protect it from possible impacts (see Figure 1 and Figure 2). Once the desired height for the fixing of Reference Points has been reached, the RPIM will stop and the ROV will navigate autonomously or teleoperated out of the cage towards the desired fixing point. Once the fixing process is finished, the ROV will return to the cage and continue the descent of the RPIM. The RPIM will place said RPs only in the flooded section, since the dry section would require additional machinery. The design criteria for the RPS requires passive units, to avoid the use of batteries or electrical wiring, in order to minimize the need for maintenance, which would be challenging and potentially costly in the flooded shaft.

To accomplish this requirement two possibilities have been considered. First, the use of RFID (Radio Frequency Identification) tags. Taking into account that the water of the mines presents a high conductivity, the dispersion of the magnetic fields is very high (inversely with the cube of the distance (Domingo, 2012, Meybodi et al., 2011)), requiring work in the low frequency spectrum (LF, 120-150 kHz) to minimize this effect. These frequencies, however, would require very long antennas, and, therefore, very large reference points. Due to the practical issues and potential costs of installation of large reference points the possibility of benchmarking using RFIDs was ruled out. The second possibility seeks to take advantage of the acoustic technologies available. Bearing in mind that an ultrasound scan of the shaft wall will be carried out, the Passive Reference Point will consist of a three-dimensional volume easily distinguishable from the medium. The final dimensions of the RPs have been adapted to the sonar resolution.

The final design, as shown in (Figure 8), is a triangular prism of 10 mm high and 130 mm side, since the Profiling Sonar has more precision of depth than lateral. The selection of the size of the reference points has been taken according to the minimum dimensions that the Profiling Sonar can detect in the worst case: that is, when the distance between the sensor and the wall is maximum. It has been considered that this maximum

distance is 5 m considering that it is the maximum radius found in the shafts of the mines studied in this project (see Figure 8).

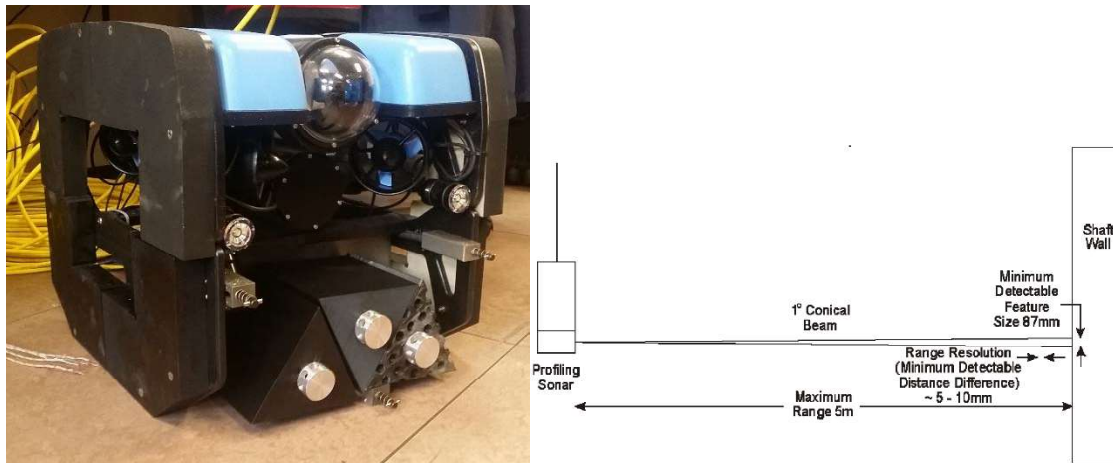

Figure 8 Design of the triangular reference points, arranged in the housing of the fixing mechanism, the minimum size of an element on the wall that the Profiling Sonar can detect is 87 mm when the distance between the sensor and the wall is 5 m.

### *Remotely operated vehicle (ROV) Autonomously Operated Vehicle*

Due to the novel conditions that the flooded mines represent for underwater inspection, the use of a simulator is required to predict the possible behaviour of the submarine vehicle and the sensors before real-life tests. The UWSim or Underwater Simulator, is a simulator of open-source submarine vehicles, which includes the necessary sensors for navigation, such as IMUs, sonar for obstacle avoidance, RGB cameras, depth sensors, force sensors, etc. It also provides an interface with ROS (Robot Operating System (Quigley, 2009), which allows acquisition and processing of this data, or send commands to the actuators through ROS nodes. This allows simultaneous operation of the underwater vehicle and the simulator. A sensor model has also been developed that emulates the behaviour of a Profiling Sonar, including the characteristics of commercial sensors. The data will be acquired through the UWSim and will be processed with the Point Cloud Library (PCL).

The ROV used for this project is the BlueROV2 (Figure 8). Given that in the worst case the conditions of visibility will be zero, the rest of the available sensors (Profiling Sonar, IMU) will be used to implement a sensorial combination that allows obtaining of the position of the ROV with the minimum possible error. With this, an algorithm will be implemented that makes the ROV autonomous, with the possibility of teleoperating it when necessary. It will therefore have both management functions: teleoperated (ROV) and autonomous (AUV). All these algorithms will be developed in the simulator first, to later implement them in the real robot.

### *Fixation tool*

The methods of fixing the Reference Points that have been studied are bonding, drilling and direct fixing. The possibility of bonding was discounted due to the high amount of dirt or suspended solids present on both the walls of the mine and in the water, as this would require a complicated pre-treatment of the surface. The drilling thrust depends on the geometry of the drill (diameter, point angle, lip length, evolution of the cutting angles along the edges, etc.), the cutting conditions (cutting speed, feed rate, lubrication, etc.) and on the material's properties. The influence of the material's properties on the cutting thrust is characterized by the hardness or by the coefficient which depends on the shear flow stress.

It was observed that overall the thrust was linear with hardness, in other places the variation of thrust was not necessarily regular and linear, in particular for iron-carbon alloys. Parameters related to the material, other than hardness, can modify the cutting thrust level. It is recognized that the presence of oxide and



sulfate inclusions in the slim form leads to a cutting force reduction. Reduction of adherence between chip and tool results in a reduction of the cutting thrust. In a wet hole or unconsolidated material, it will be necessary to feed the hammer slowly to sufficiently clean the hole as the hammer is advanced. A rotatory drill is obtained with a hammer action. The hammering action provides short hammer thrust to pulverize relatively brittle material. These drill strings work in torsion and experience axial and torsional vibration. Those high and complex forces and torques would be very difficult to compensate by the ROV, which leads to this possibility being discounted in this case.

Another possible approach is using tools for direct fastening. In these tools, the fastener driving power is generated by a power load of combustible gas or compressed air. They are self-centering, and used for deep holes, providing high cutting speeds. The bits use a rotary motion similar to a twist drill, but the bits are designed with bearing pads that slide along the surface of the hole keeping the drill bit on the center. They can work in both steel and concrete. Other advantages of this system for the application of the RPID, are its simplicity, the no need of electric powder and its high speed. As such, direct fastening is the method of choice, because advantages such as self-centering, concrete or steel applicability. Moreover, there is no electric power consumption, due that firing is activated electronically and the power provided by the internal powdered cartridges.

### 3.6 Communication module

The Figure 9 represents the main modules and the communication protocols that each one has with the central station via CIS (Cable Interface Unit):

- The RIPM is formed by the DSS, the AUV with the fixation device and the PCAS. The AUV is connected with the DSS via Ethernet, and then the DSS transmits the information via RS 232, GPIO, and analog Video /HDMI.
- The Ultrasonic Inspection Module (UIM) collects sensor data from Profiling Sonar and GRS. Those data are sent to the CIS via RS 232.
- The Multifunctional Monitoring Module (MMM), similarly to the UIM, collects sensor data and sends it uphole. The images from the CCTV are sent to the CIS via RS-485.

All those modules will work concurrently, but the operation of all of them will be managed by a common modular software. This software will facilitate the operation of the corresponding hardware device.

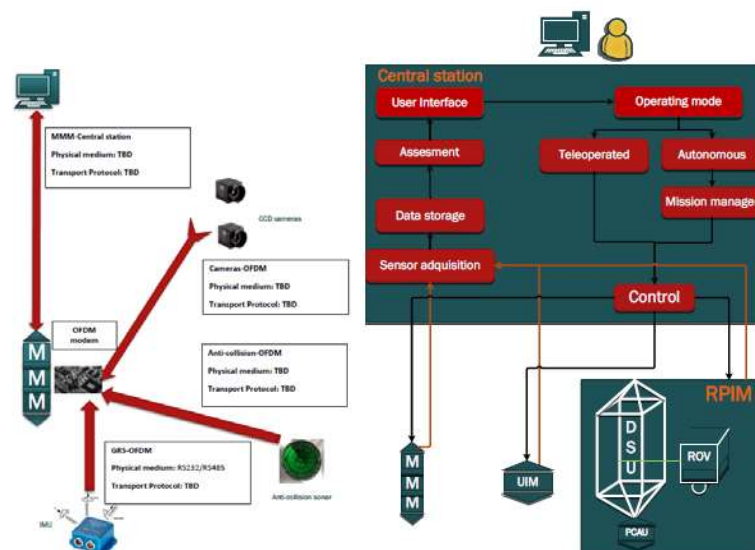

Figure 9 Communication modules and the communication protocols

## 4 Continuous Monitoring

### 4.1 Introduction

While the Periodic Inspection Modules allow detailed inspections and measurements to be made on an infrequent basis, the complementary continuous monitoring regime has been designed to make a more restricted range of measurements but to allow them to be made on a continuous basis. The system includes two elements – a tube bundle system and an electronic sensor system – so that end users may choose to implement one or both, depending on their budget and the requirements of a particular shaft. In the event that both elements are installed, a degree of redundancy is provided. So long as the electronic sensor string and the tube bundle are widely separated within the shaft's cross-section, it is considered likely that any incident that damages one element would probably not affect the other so a degree of continuous monitoring would remain operational.

### 4.2 Tube Bundle System

The tube bundle system works on the same principle as the tube bundle systems that are often employed in working mines, mostly in Australia and China, but with some limited use in European mines. The method of working involves drawing samples of the atmosphere from different parts of the mine, using a pump, via different sample tubes within the bundle, for chemical analysis at the surface – see (Zipf *et al.*, 2013) and (SIMTARS, 2015). It is envisaged that very similar surface equipment to that used in working mines could be used, to sample air in the dry portion of abandoned shafts, although a special tube bundle has been designed to withstand the hostile conditions that could be encountered in an abandoned shaft. This takes into account the fact that the underground elements of the continuous monitoring systems must be considered “fit and forget” systems that are capable of operation for many years or decades without the option of maintenance. Initially, consideration was given to also using the tube bundle for water sampling in the flooded portion of a shaft but this was abandoned because the submersible pumps that would be required would not meet the requirement of a long operating life without the option of maintenance. This decision also embodied the philosophy of using each of the continuous monitoring systems for the environment and application for which it is most suitable.

Conventional tube bundles employ several sample tubes surrounded by an outer layer but, for this application, a novel three-element tube bundle was designed to meet the requirement of increased resilience to impacts. It is shown in Figure 10. The three elements are (1) the sample tubes which are made of polyethylene, (2) an intermediate yielding layer, designed to absorb impacts, made of thermoplastic polyurethane, and (3) an outer layer made of PVC with an anti-static additive.



Figure 10 Prototype of Extra-resilient Tube Bundle

Tests, involving dropping weights onto pieces of the tube bundle prototype, demonstrated a good degree of resilience. In particular, a weight of 64kg, dropped from a height of 2m, resulted in abrasions and some tearing on one side and a cut on the other of the outer layer, although neither was full depth. No damage occurred to the intermediate layer, and moderate flattening and lateral crush marks occurred to the sample tubes, although they were still completely airtight. Although more severe incidents, such as segments of cage rails or steel pipes coming loose and hinging into the tube bundle, would undoubtedly destroy the tube bundle, indeed it would be prohibitively expensive to provide protection against such severe incidents, it is considered that the bundle will survive a large proportion of possible in-shaft incidents.

Unlike the situation with active mines, where joint boxes allow sample tubes to be directed to a large number of different areas of the mine in a tree-like structure, in this application it is necessary only to provide a means by which a single sample tube can be extracted from the bundle at a small number of depths in the shaft to allow atmospheric sampling. To achieve this, a so-called breakout box has been designed and prototyped. Attention has also been given to support for the tube bundle because it will often be installed post-closure, so there will be no opportunity to attach it to the shaft lining at regular intervals, as would be the case in a working mine. Support is achieved using a synthetic 16mm double braided rope with a Dyneema core and a polyester outer cover. The tube bundle is clamped to the rope at regular intervals and also immediately above and below each breakout box as shown in *Figure 11*.



**Figure 11 Breakout Box Fitted to Tube Bundle with Support Rope Attached**

### 4.3 Electronic Sensor System

The electronic sensor system can be used in both the dry and the flooded section of a shaft even though, in most cases, different sensors would be used in these two regions of the shaft. Several initiatives have been developed to reduce the cost of installing an electronic sensor system and to achieve the aim of providing a “fit and forget” solution. This will make implementation more attractive to the end user, thereby increasing the number of systems that may be installed, and increasing the system lifetime to achieve the required long-term monitoring capability.

One of the most innovative technologies to be developed, for reducing installation cost and increasing long-term reliability, is a scheme for the contactless transfer of power and data between the sensors and the line. A previous version of this type of telemetry system was developed for use in transport tunnels (European Commission, 2008), but there has been no known similar development for use underwater.

In the scheme developed for abandoned shaft monitoring, each pod of sensors (known as an out-station) is contained in its own pressure-proof housing and receives power by inductive coupling to an external line carrying a low frequency alternating current. The same line carries data, which is modulated on a low frequency carrier, and which is also coupled inductively, allowing bi-directional data transfer. Typically, each out-station would be polled in turn by a master control unit, and asked to upload its data or to report its status.

The single power/data line comprises a braided stainless steel core cable with a thick polypropylene outer cover, which may in principle be several kilometres in length. The significant feature of the system is that there are no direct connections to the out-stations. Connectors for submarine housings – or ‘penetrators’ as they are known – can be extremely expensive. The absence of penetrators, coupled with a simple design of pressure-proof housing capable of withstanding 200 bar, helps to achieve significant cost and reliability benefits. An additional feature that contributes to the cost-effectiveness is that the housings are designed to fail ‘safe’. As the water level rises in the shaft, the housings under the most pressure stress can fail without affecting the integrity of the rest of the system.

The out-stations contain a high-quality piezo-resistive pressure sensor, to allow them to measure water depth, as well as sensors for temperature, accelerometer (for detecting motion in the water that could be indicative of shaft stability issues) and water conductivity. The ends of the pressure-proof housing are metal and the body is plastic, so this allows a simple two-terminal resistance measurement. In theory, the housing could be adapted for a four-terminal measurement, which is more reliable in conditions of high conductivity.

This project has also looked at the scope for contactless conductivity measurement and at methods for correlating conductivity (and temperature) with pH value.

Internally, the most obvious method of providing power is from a small rechargeable battery, charged via the inductive coupling. However, such batteries do not have a long lifetime, especially when trickle-charged on a continuous basis, which was the original intention. It has therefore been necessary to include a power management utility in the software, and to consider the use of super-capacitors as an alternative to conventional batteries. There are several possible inductive coupling topologies, the simplest of which is the toroid. However, a toroidal coupling is difficult to assemble in the field, especially if one wants to avoid breaking and re-joining the cable. Other topologies such as a loosely-coupled bobbin have been investigated.

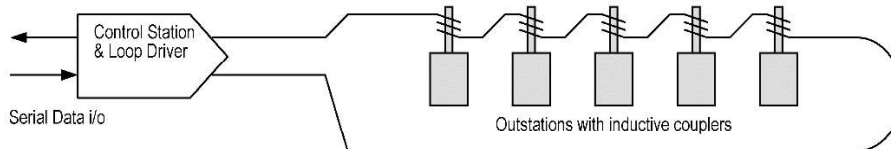

**Figure 12** Block Diagram of Underwater Transmission Scheme The control station features a high-stability trans-conductance amplifier and bridge driver. The communications line couples inductively to the outstations and transfers power and data.

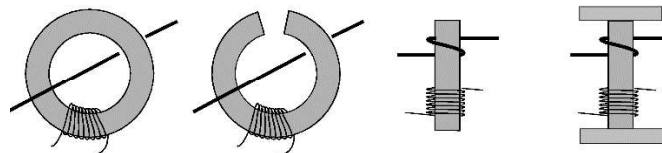

**Figure 13** Examples of Inductive Coupling A toroid has practical disadvantages. However, other arrangements, as shown, result in only loose coupling. The bobbin (right-most figure) is considered the most practical configuration.

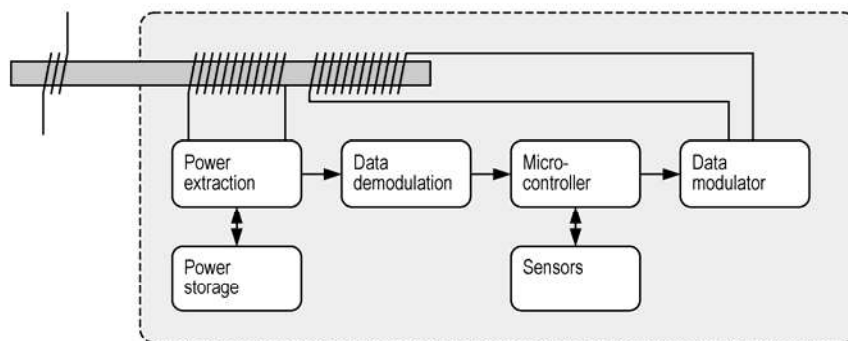

**Figure 14** Block Diagram of an Out-station

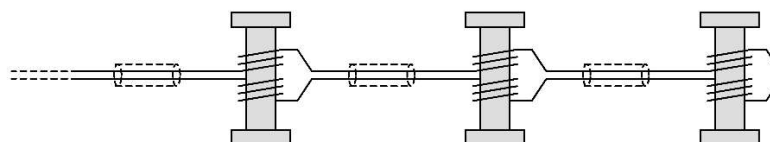

**Figure 15** Common-mode Noise Reduction using a Paired Line

## 5 Long term stability modelling

Shaft long-term stability after its closure is mainly governed by the behaviour of its lining which is generally composed of concrete or brick/masonry. Tubbing mainly with cast iron is sometimes used when crossing aquifer formations particularly for very old shafts. Shaft stability becomes critical during the flooding phase where lining is attacked by highly polluted water with aggressive minerals such as sulphates and chlorides. This leads to lining weakening and its potential failure, inducing thereafter the risk of shaft collapse.

The flooding phase involves three kinds of loadings applied on the lining (Corvisier et al., 2010). The first one is mechanical and is linked to shaft sinking and lining installation (permanent stress regime). The second loading is hydraulic and is related to water table regime (water pressure). The last loading is due to corrosion and chemical reactions which occur between mine water and lining materials (loss of thickness and degradation of mechanical properties). Hence, to deal with long term stability of a shaft, it is necessary to examine the risk linked to each one of these three loadings and to couple them at the end for a reliable assessment.

The mechanical behaviour of shaft and lining may be studied by classical approaches (either analytical or numerical) using the convergence-confinement method to evaluate properly the loading within the lining. This requires of course knowledge of the geological and geotechnical properties of the host rocks, the geometrical data of the shaft (depth and diameter), the lining properties (composition along the depth, thickness and mechanical properties) as well as the procedure of lining installation. For the hydraulic aspect, both the hydrogeological data of the grounds and the lining hydraulic properties are required. Numerical hydromechanical models can then be used to forecast the excess of loading brought on the lining by the water table regime.

The chemical loading needs more detailed data especially at the lining level. The composition of the material as well as the mine water which will be in contact should be known. This operation is done commonly by in-situ sampling and by laboratory measurements (optical microscopy, electron probe microanalyser and X-ray diffraction for lining material and pH, conductivity and chemical composition for mine water). Batch leaching tests can be also carried out and their results analysed in terms of solution composition as well as solid phase. Based on measured properties, the potential chemical reactions and pathologies are evaluated and dedicated numerical models coupling geochemistry with transport are implemented to study the durability of lining. These models consider the thermodynamics and kinetics of the materials in aqueous solutions and the reactive transport to estimate the altered thickness of the lining during the considered period.

At the end, shaft stability is evaluated by calculating a safety factor which is defined as the ratio of the lining material strength by the active stresses. For the hydraulic and mechanical aspects, coupling is classical and the evaluation of the safety factor is obvious provided using consistent assumptions in numerical modelling and reliable mechanical and hydraulic properties. However, for the chemical aspect, full coupling is not easy. The proposed approach is simple and consists of simulating the chemical reactions and estimating the degraded width from each lining side (internal face inside the shaft and external face rockmass side). This degraded width is supposed to be totally ineffective and lost and therefore lining thickness is reduced from each side by this width. The remaining part of lining is assumed to preserve the initial mechanical properties of the material without any weakening effect. Stability can be therefore assessed by establishing charts giving the variation of the safety factor for a given thickness and strength of the lining material and given conditions of the shaft (geometry, mechanical and hydraulic loadings). Within the project, this approach was applied at three different levels: first, illustrating its principle on three French shafts lined with concrete and cast iron where sufficient data were available on the required characteristics of the rockmass, lining and mine water. Two Polish shafts which have collapsed by lining failure were then back-analysed to demonstrate the capability of the approach to reproduce observed behaviour. Finally, the long-term stability of selected shafts from partner's sites was assessed using the available data. An illustration of the modelling results on two French shafts lined with concrete is given by Figure 16 and 24.

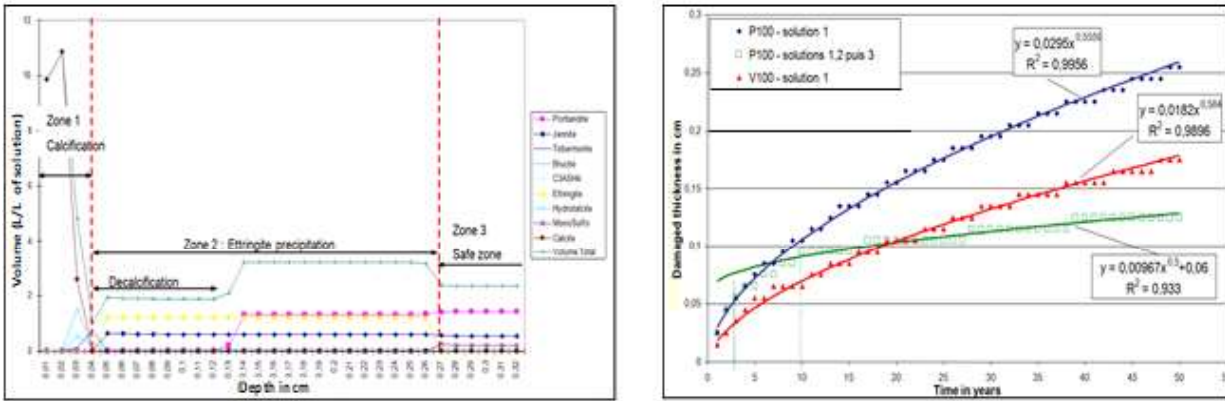

Figure 16 Illustration of chemical attack of concrete lining by mine water and progress of the degraded front with time

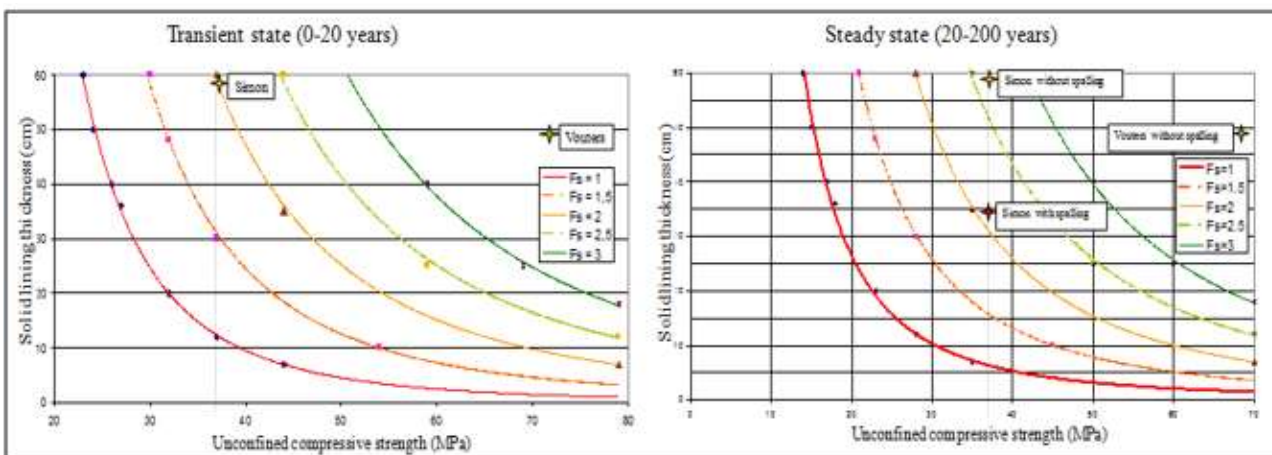

Figure 17 Stability conditions of the two shafts for the transient and steady phases

Parallel to the modelling work, a testing programme was set up on concrete samples submitted to different water solutions. Concrete was selected as it represents the most common shaft lining material in coal mines. The aim of the tests is to validate the parameters assumed in modelling particularly in relation with the chemical and mechanical aspects.

## 6 Conclusion

The stability of abandoned mine shafts is a major cause of concern, because of the risk to life and property in the case of collapse. For this reason, there is significant interest in being able to inspect shaft linings for signs of damage. Significant work has been carried out into developing inspection methods for dry mine shafts but flooded shafts pose a greater problem. Because most shafts will, eventually, become at least partially flooded, the STAMS research project is developing inspection technologies for flooded, abandoned mine shafts.

Instruments, which will be winched down the shaft from the surface, have been developed for carrying out periodic inspections. The Multi-functional Monitoring Module will carry out an extensive range of measurements, including video inspection, sonar investigations and water analyses. The Ultrasonic Inspection Module is designed for end users with a lower budget, and allows for accurate cross-sectional details to be recorded via sonar. Major differences in the results obtained during consecutive deployments is indicative either of damage or deterioration of the shaft lining.

To augment detailed periodic inspections, techniques for more limited monitoring, but on a continuous basis, have been researched. First, a tube bundle system has been designed for sampling the atmosphere at various

depths in the dry portion of a shaft. This operates in the same way as similar systems in working mines but the tube assembly has been designed to withstand the harsh conditions in abandoned shafts to provide long-term, maintenance-free monitoring. Second, various technologies for implementing a system of electronic sensors, for use above and below the water level, have been researched. Key techniques include a method of contactless power and data transfer, and a means of ensuring that any sensors that fail do not jeopardise the complete system. Both ensure low-cost installation and long-term operation.

Chemical reactions between mine water and lining materials, and the resulting alteration, may weaken the stability of the lining and induce failure. The risk of failure is greater with more critical initial stability conditions before flooding, and with acidic mine water. The uncertainties about the many types of data, required to carry out coupled modelling to assess the long-term stability of mine shafts, highlight the importance of monitoring and the need to implement innovative inspection and monitoring tools.

## Acknowledgement

The authors would like to thank the European Commission for their support and funding of the STAMS research project.

## References

- Bock S. 2014. Numerical modelling of a void behind shaft lining using FDM with a concrete spalling algorithm. *Journal of Sustainable Mining*, 13(2), 14–21. doi:10.7424/jsm140203
- Corvisier et al. 2010. Raman mapping and numerical simulation of calcium carbonates distribution in experimentally carbonated Portland-cement cores, *Eur. J. Mineral.* 2010, 22, 63–74
- Domingo, M., 2012. Magnetic Induction for underwater wireless communication networks, *IEEE Transactions on Antennas and Propagation* 60.
- European Commission (2008), Cost-effective sustainable and innovative upgrading methods for fire safety in existing tunnels (UPTUN), Deliverable 3.3: Human Factors Aspects in Tunnels: Tunnel User Behaviour and Tunnel Operators, 5th Framework Programme, contract G1RD-CT-2002-766
- Gomez, F., Althoefer, K., Seneviratne, L.D., 2004. An ultrasonic profiling method for sewer inspection, *IEEE International Conference on Robotics and Automation* 5.
- Lecomte A., Salmon R., Yang W., Marschall A., Purvis M., Prusek S., Bock S., Gajda Ł., Dziura J. 2012. Case studies and analysis of mine shafts incidents in Europe. 3<sup>rd</sup> International Conference on Shaft Design and Construction, London 2012, *Tunnels and Tunnelling International*, April 2012, pages 60-65.
- Lefebvre, A., Thompson, C.E., Collins, K.J., Amos, C.L., 2009. Use of a high-resolution profiling sonar and a towed video camera to map a *Zostera marina* bed, Solent, UK, *Elsevier* 82, n° 2.
- Meybodi, S., et al., 2011. Magneto-Inductive Underground Communications in a District Heating System. ICC, 2011.
- Prats, M., Pérez, J., Fernández, J. J., Sanz, P. J., 2012. An open source tool for simulation and supervision of underwater intervention missions.
- Robotics, Blue. BlueROV2. s.f. <http://docs.bluerobotics.com/brov2> (último acceso: 27 de Abril de 2017).
- SIMTARS (2015) The Application of Tube Bundle Systems in the Prevention of Mine Fires and Explosions and Post-event Response, SIMTARS Report OG172865F1 (prepared for the National Institute for Occupational Safety and Health under contract number 200-2013-56949), 30 June 2015.
- Whitworth, K.A. 2002. The monitoring and modelling of mine water recovery in UK coalfields. In: Younger, P.L. & Robins, N.S. (eds) *Mine Water Hydrogeology and Geochemistry*. Geological Society, London, Special Publications, 198, 61-73.
- Zipf, R. K.; Marchewka, W.; Mohamed, K.; Addis, J.; Karnack, F. (2013) Tube Bundle System for Monitoring of Coal Mine Atmosphere, *Mining Engineering*, Vol. 65, No. 5, pp. 57 - 63.