



HAL
open science

Selection, instrumentation and characterization of a pilot site for CO₂ leakage experimentation in a superficial aquifer

Philippe Gombert, Zbigniew Pokryszka, Stéphane Lafortune, Julie Lions, Frédéric Gal, Catherine Joulian, Solenne Grellier, François Prevot, Yacine Darmoul, Patrice Squarcioni

► To cite this version:

Philippe Gombert, Zbigniew Pokryszka, Stéphane Lafortune, Julie Lions, Frédéric Gal, et al.. Selection, instrumentation and characterization of a pilot site for CO₂ leakage experimentation in a superficial aquifer. 12. International Conference on Greenhouse Gas Technologies (GHGT-12), Oct 2014, Austin, United States. pp.3172-3181, 10.1016/j.egypro.2014.11.342 . ineris-01855578

HAL Id: ineris-01855578

<https://ineris.hal.science/ineris-01855578>

Submitted on 31 Aug 2018

HAL is a multi-disciplinary open access archive for the deposit and dissemination of scientific research documents, whether they are published or not. The documents may come from teaching and research institutions in France or abroad, or from public or private research centers.

L'archive ouverte pluridisciplinaire **HAL**, est destinée au dépôt et à la diffusion de documents scientifiques de niveau recherche, publiés ou non, émanant des établissements d'enseignement et de recherche français ou étrangers, des laboratoires publics ou privés.

GHGT-12

Selection, instrumentation and characterization of a pilot site for CO₂ leakage experimentation in a superficial aquifer

Philippe Gombert^{a,*}, Zbigniew Pokryszka^a, Stéphane Lafortune^a, Julie Lions^b, Frédéric Gal^b, Catherine Joulian^b, Solenne Grellier^c, François Prevot^d, Yacine Darmoul^d, Patrice Squarcioni^e

^aINERIS, Parc Technologique Alata, 60550 Verneuil-en-Halatte, France

^bBRGM, 3 Avenue Claude Guillemin, 45100 Orléans, France

^cVeolia Recherche & Innovation (VERI), Chemin de la Digue, 78603 Maisons-Laffitte, France

^dInstitut de Physique du Globe de Paris, Sorbonne Paris Cité, Univ. Paris Diderot, UMR 7154 CNRS, 1 rue Jussieu, 75005 Paris, France

^eHYDROINVEST, 514 route d'Agris, 16430 Champniers, France

Abstract

CO₂ geological storage is one of the options for mitigation of GHG emissions into the atmosphere. Although storage is provided for several millennia, leakage can occur. Therefore the risk that the fugitive CO₂ reaches a shallow aquifer cannot be excluded [1]. That is why the consortium launched the research program CIPRES, funded by the French Research Agency, concerning the potential impacts of CO₂ leakage on groundwater quality. This program includes the realization of a shallow CO₂ release experiment in a carbonated aquifer and its monitoring in the saturated and unsaturated zones, the soil and the soil-atmosphere interface. The experimentation consists in drilling a well into the aquifer, injecting dissolved CO₂ in water [2] and tracking its impact downstream. Prior to this experiment, a site had to be selected, instrumented and characterized.

Hydrogeological target is the Paris basin chalk which is the largest French aquifer. The selected area is a large parcel, formerly cultivated in intensive monoculture but left fallow for several years, located in Catenoy (Oise) about 50 km north of Paris. The geological log shows the chalk is covered by 6-7 m of sands but water table is located at 12-13 m depth, i.e. integrally in the chalk strata.

The site has been equipped with 10 wells to characterize the groundwater flow (hydraulic gradient $\sim 5 \cdot 10^{-3}$). 6 wells are aligned in the groundwater flow direction: the PZ2, planned for CO₂ injection, the PZ1 located 20 m upstream and 4 monitoring wells located downstream between 10 and 60 m from PZ2. There are also 4 lateral piezometers located near (PZ7, PZ8) and far (PZ9, PZ10) from the injection site: they are dedicated to the lateral plume. These 25 m depth wells are equipped with tubing fully slotted in the chalk. Alongside, 4 wells dedicated to gas monitoring in unsaturated zone have been drilled at 1 m depth.

* Corresponding author. Tel.: +33-(0)344-556-234; fax: +33-(0)344-556-700.

E-mail address: philippe.gombert@ineris.fr

To characterize the site, the following operations were performed prior to the CO₂ injection between March and September 2013:

- pump test into PZ2 to estimate the hydraulic conductivity (10^{-3} m.s^{-1}) and the storage coefficient (1.6%); the hydraulic conductivity is higher in the first 3 m of saturated zone ($\sim 5 \cdot 10^{-3} \text{ m.s}^{-1}$);
- hydrogeochemical baseline with monthly water analysis in each well (physicochemical parameters, major and minor ions, metallic trace elements); electrical conductivity is $714 \mu\text{s.cm}^{-1}$ and groundwater has a calcium-bicarbonated facies with high nitrate concentration (45 mg.l^{-1}) and low-level presence of trace metals;
- gas baseline with continuous O₂ and CO₂ measurement in vadose trough 11 m depth boreholes and measurements campaigns to determine gas concentration in the soil and gas flux on the surface;
- flowmeter heatpulse logging at PZ2, PZ3 and PZ4 in static and dynamic conditions; only the area situated from 15 m to 20 m depth is productive and a vertical natural downflow is measured in PZ3 ($\sim 1\text{-}2 \text{ mm.s}^{-1}$) and PZ4 (1 cm.s^{-1}); furthermore, no flow is measured from 20 to 25 m depth; this confirms the vertical anisotropy of the chalky aquifer;

Following this experiments, a tracer test has been done in June 2013 from PZ2 with fluorescent tracer (amino-acid G) and a dissolved gas (He), in the way to calibrate the future CO₂ injection and its monitoring. 2 m³ of water from the aquifer were pumped the day before the injection and stored in tanks. Then 2 kg of tracer were dissolved and water was saturated with He. This water was injected into the PZ2 the next day during 8 h. The monitoring was conducted for a month by water sampling, tracer and He analyzes. The peak of fluorescent tracer arrived at the 2nd day following injection in the PZ4 (20 m downstream) but only one week later in the PZ3 (10 m downstream), due to the site anisotropy. Low He concentrations have been detected in the unsaturated zone of PZ4 before PZ3, in correlation with tracer migration.

The main result is the existence of an high aquifer anisotropy in such a small area: i) the first 3 m of the saturated zone shows a higher permeability and the last 5 m a lower one, ii) the tracer arrives quickly and with higher concentration at PZ4 located 10 m farther than PZ3. However, the dilution ratio is rather important and may induce, during CO₂ leakage experimentation, a slight pH decrease at the downstream wells: in order to increase the impact of the CO₂ leakage, we have therefore planned to inject a higher volume (10 m³) of CO₂ saturated water.

© 2014 The Authors. Published by Elsevier Ltd. This is an open access article under the CC BY-NC-ND license (<http://creativecommons.org/licenses/by-nc-nd/3.0/>).

Peer-review under responsibility of the Organizing Committee of GHGT-12

Keywords: CCS, CO₂, leakage, groundwater, hydrogeochemistry, impact

1. Site presentation

The experimental site is located near the municipality of Catenoy (Oise), about 50 km north of Paris, in a vast uncultivated land (Fig. 1). The geological context is the Senonian chalk covered by a few meters of thanetian sands and colluvium. The tested aquifer is the chalk one.



Fig. 1. The experimental site of Catenoy with its piezometers PZ1 to PZ8

2. Preliminary characterization

2.1. Site equipment

Ten water wells called piezometers (referred as PZ and numbered from PZ1 to PZ10) were drilled on the site (Fig. 2):

- PZ1 monitors the groundwater at 20 m upstream of the injection well ;
- PZ2 is the injection well;
- PZ3 to PZ6 allow groundwater monitoring between 10 and 60 m downstream of the injection well;
- PZ7 to PZ10 help checking the absence of incoming laterally groundwater.

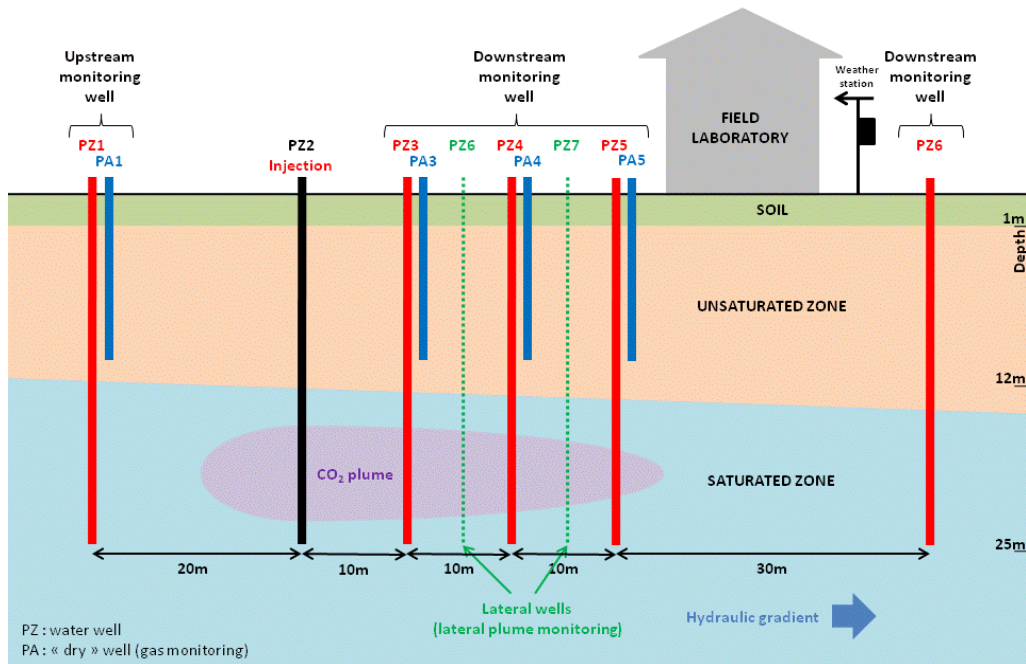

Fig. 2. Schematic section of the experimental site and its facilities

The geological logs of the piezometers are similar and show:

- 6-7 m of clayed fine sand, brown to red (top of thanetian sands and sandy colluviums),
- 18 to 21 m of white chalk with flint (Senonian).

All the piezometers are slotted in the chalk with a 80-90 mm HDPE casing. The cement used is acid resistant.

2.2. Monitoring of the saturated zone

The water table is around 12 m deep with annual variations of about ± 1 m. The groundwater flow is directed from West to East, i.e. from PZ1 to PZ6, with a hydraulic gradient of $5 \cdot 10^{-3}$.

Several probes are installed in the piezometers for a continuously physico-chemical monitoring:

- Water level, temperature and electrical conductivity at PZ1, PZ2, PZ3;
- Dissolved oxygen in PZ3;
- pH in PZ3 and PZ5

pH measurement in PZ5 is based on the experimental APASCH colorimetric system [6,7]. It measures the color change of Bromocresol Purple indicator between 5.2 and 6.8 (respectively corresponding to the predicted pH of CO₂ saturated water and to the pH of natural groundwater). The apparatus includes a spectrophotometer, a cell sample reagent mixture and an electronic control box (Fig. 3).

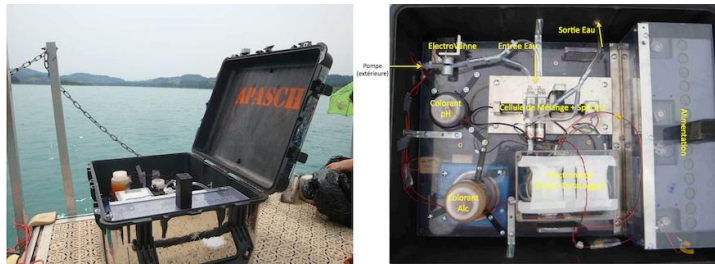

Figure 1. The APASCH system in its carrying case

2.3. Monitoring of the unsaturated zone (UZ)

It is also needed to detect any CO₂ degassing from groundwater downstream the CO₂ injection well, and to monitor its transfer in a free gaseous phase through the overburden. This is to determine the potential buffer role of UZ and soil in case of CO₂ leakage.

Four other wells have been drilled and dedicated to the UZ gas monitoring and called “air piezometers” (referred as PA and numbered from PA1 to PA5, see Fig. 2) They are only 11 m deep and located 2 m from their counterpart water piezometer. They are equipped with a slotted PVC casing up to 3 m below the surface, then with a full cemented casing.

Gas monitoring is achieved by a recirculation method with continuous analysis (Fig. 4). This method has been developed by INERIS and used on many other sites [3, 4, 8].

Each PA is equipped with two CO₂ sensors (one with a 1 ppm resolution in the 0-2% range, another one with a 0.01% resolution in the 0-100% range), an oxygen sensor (with a 0.1% resolution in the 0-25% range). In the PA3, a radon (²²²Rn) activity sensor and a temperature sensor were also installed.

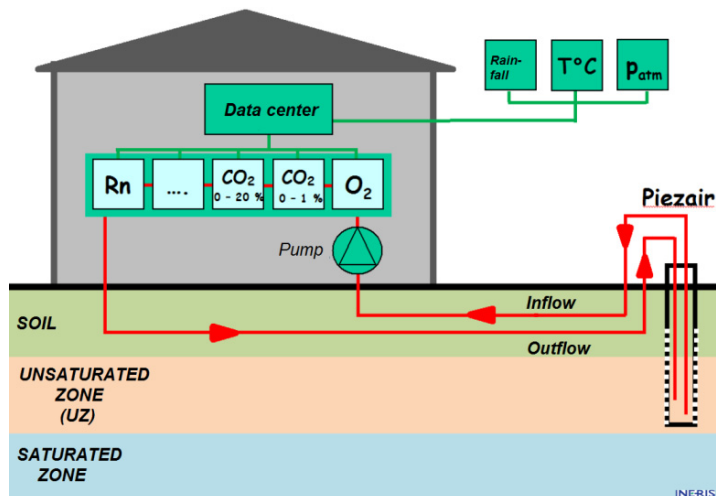

Fig. 4. Scheme of gaseous monitoring in unsaturated zone (PA)

2.4. Monitoring of soil and soil-atmosphere interface

Gaseous measurements in the soil and at the soil-atmosphere interface complement the UZ monitoring. In the eventuality of a significant free gas leakage following a CO₂ injection in the aquifer, these measures help to detect any gas outlet at the surface and to determine its emission parameters (concentration and rate). Thus, they focus on the main components of soil gas and the determination of gaseous CO₂ fluxes from the soil.

The measurements of the soil gases composition are done through 1 m deep tubes with a method proposed by [5] and already used on other sites [8]. These tubes are connected to field gas analyzers (Fig. 5 left).

The CO₂ flux measurements (Fig. 5 right) are performed using the accumulation chamber with external recirculation developed and patented [3].

All this measurements are performed on 19 points at the surface of the experimental site, plus 5 reference points located near outside the site.

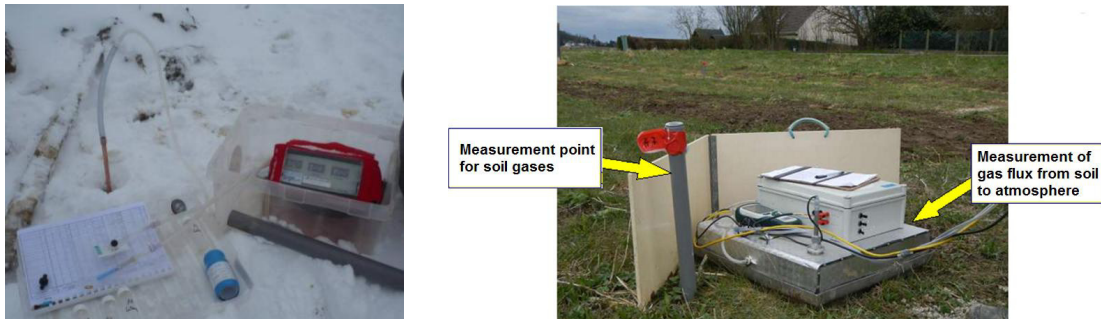

Fig. 5. Extraction and analysis of soil gases (left) and gaseous flux measurement (right)

3. Hydrodynamical characterisation

3.1. Pumping test

The PZ2 has been pumped for 12 hours at 7.6 m³.h⁻¹ flow rate. Total drawdown reached 5.02 m and all the other piezometers were influenced. The hydraulic characteristics obtained are as follows:

- transmissivity $T = 1.53 \cdot 10^{-2} \text{ m}^2 \cdot \text{s}^{-1}$
- hydraulic conductivity $K = 1\text{-}5 \cdot 10^{-3} \text{ m} \cdot \text{s}^{-1}$ depending on the aquifer height (see § 3.2).
- storage coefficient $S = 1.58 \cdot 10^{-2}$
- diffusivity $D = T/S = 1.23$

The transmissivity value is high for a chalk matrix aquifer, so another type of porosity must be present (cracks, fractures or karst). The storage coefficient characterizes an unconfined aquifer but high diffusivity indicates a confined behavior: in conclusion, the aquifer appears to be semi-confined.

3.2. Logs

3.2.1 Flow rate and gamma-ray logs

A flow rate log was done in PZ2, PZ3 and PZ4, using a Heat-Pulse Flowmeter 2293 HFP Sopris Mount brand. In PZ4, a downwards natural vertical flow was revealed between 16 and 18 m depth, at a rate of 4.4 10⁻³ L.s⁻¹ (Fig. 6a). During pumping phase (of the log), most of the flow of all the tested piezometers is provided by the area between 14 and 18 m depth (Figure 6). This behavior reveals a vertical anisotropy with a productivity strata near the water table.

Gamma-ray logs show an altered chalk layer that - from PZ2 to PZ6 - could match this more permeable zone.

3.2.2 Physico-chemical logs

The 10 piezometers of the site were investigated by physicochemical logs (temperature, electrical conductivity, pH, ORP (Oxidation-Reduction Potential), dissolved oxygen). This has been done before and after each groundwater sample pumping. pH logs are presented in Fig. 6b:

- the average pH range between 7.15 and 7.25 with fairly straight profiles (except PZ6 and PZ8);
- the pumping for water sampling does not disturb the pH profiles; the maximum difference between the measurements taken before and after the pumping is 0.05 pH unit.

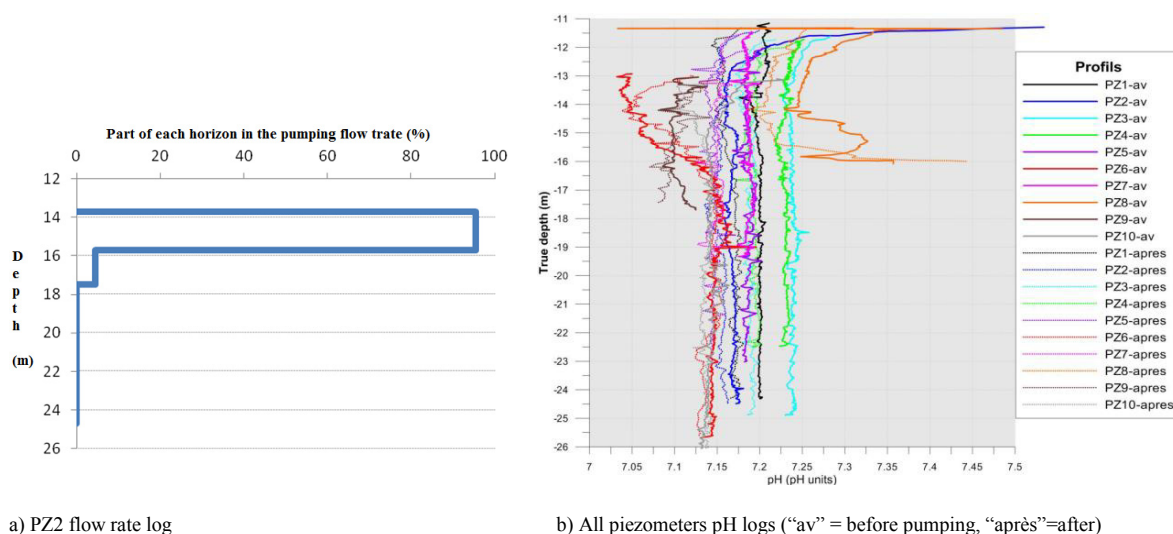

a) PZ2 flow rate log

b) All piezometers pH logs (“av” = before pumping, “après”=after)

Fig. 6. Physico-chemical logs

3.3. Natural flow tracer test

In order to calibrate the injection of CO₂ saturated water, a tracer test was realized. A mass of 2 kg of amino acid G (fluorescent tracer) is dissolved in 2 m³ of groundwater (previously extracted from PZ2) and the water is then He saturated by bubbling to provide a gaseous tracer (approximately 2 g.m⁻³).

Results from the tracer test show (Fig. 7a):

- at PZ3, located 10 m downstream, a tracer peak at 1600 µg.l⁻¹ at the 9th day following the injection, which corresponds to a velocity of ~1 m.day⁻¹ and a dilution rate of ~300 ;
- at PZ4, located 20 m downstream, a tracer peak at about 3200 µg.l⁻¹ at the 2th day, which corresponds to a velocity of ~9 m.day⁻¹ and a dilution rate of ~160 ;
- at PZ5, located 30 m downstream, a sudden increase of background noise from <5 µg.l⁻¹ to 160 µg.l⁻¹ at the 3th day but no significant tracer peak.

The tracer transfer speed is similar between PZ3, PZ5 and PZ6 with an average value around 3 m.day⁻¹. It is 3 times greater in PZ4 with a value around 10 m.day⁻¹. This indicates an horizontal anisotropy.

Helium concentrations are monitored during two months in the piezometers and the piezairs. Piezair sampling show only a small variation compared to atmospheric levels: one can note slightly higher concentrations in PA4 after 50 days (Fig. 7b). This suggests that, despite the use of a highly diffusive and non reactive gas, the majority of injected gas remains confined inside the aquifer. This is positive point for the future CO₂ injection: it indicates the risk of important outgassing is very limited and therefore it could not occur a significant loss of part of the injected gas.

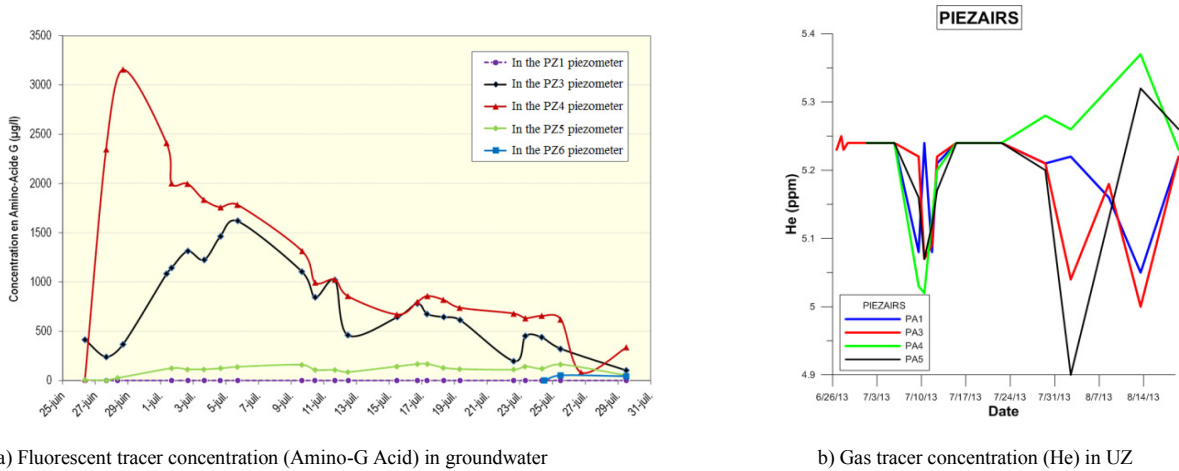

Fig. 7. Evolution of tracers concentrations in the different wells of experimental site

4. Hydrochemical characterisation

4.1. Rock analysis

A core drilling allowed rock sampling at several depths. Chalk is composed by more than 95% of calcium carbonate with a very low magnesium content. XRD analysis confirmed the presence of calcite and traces of silica which is consistent with flint levels observed at different depths. The cation exchange capacity (CEC) is relatively high in the overlying sands (15 meq) while it is negligible for chalk (<0.5 meq).

4.2. Water analysis

4.2.1 Physico-chemistry

Several *in situ* physico-chemical measurements (Table 2) and water sampling (Table 3 and Table 4) were made monthly in PZ1, located upstream of the injection well. This piezometer has been chosen to be the reference as it was not impacted by the first tracer test. The water from PZ1 is moderately mineralized, neutral, oxidized and has a calcium bicarbonate facies with significant residual nitrate (from old agricultural inputs)

Table 2. Physico-chemical parameters in PZ1 groundwater (in situ measurements)

Parameter	Temperature. (°C)	pH	Conductivity (µS/cm)	ORP (mV)	Dissolved O ₂ (ppm)	Dissolved O ₂ (% sat.)
Average	12.89	7.22	667.3	498.9	7.18	70.80
Minimum	11.20	6.78	631.0	458.1	6.05	62.70
Maximum	14.50	7.40	697.0	522.2	8.83	80.80
Mediane	13.00	7.22	669.0	506.7	7.16	71.60
Number of values	12	12	12	10	10	10
Standard deviation	1.20	0.16	19.70	20.61	0.76	5.11

Table 3. Major and minor ions concentrations (mg.L^{-1}) in PZ1 groundwater

Parameter	Ca	Mg	Na	K	HCO_3	Cl	SO_4	NO_3	NH_4	NO_2	PO_4	SiO_2	DOC	DIC	SM
Average	102.9	13.0	16.0	5.3	302.4	30.0	28.6	38.8	<DL	0.1	DL	8.2	16.0	47.3	31.8
Minimum	95.0	12.0	13.9	5.0	285.5	26.4	21.6	34.9	<DL	0.0	<DL	0.4	10.5	37.9	0.3
Maximum	110.0	15.0	18.0	5.5	309.9	32.3	31.6	46.8	<DL	0.2	<DL	9.5	25.8	52.8	57.3
Median	102.7	13.0	16.0	5.2	304.8	30.4	29.3	37.1	<DL	0.0	<DL	9.1	13.8	49.3	37.8
Number of sample	13	13	13	13	10	13	13	13	6	13	10	10	4	4	3
Standard deviation	4.7	1.0	1.2	0.2	8.3	1.6	2.8	3.4	-	0.1	-	2.7	6.91	6.85	29.0

DOC = Dissolved Organic Carbon, DIC = Dissolved Inorganic Carbon, SM = Suspended Matters, DL = Detection Limit

Table 4. Dissolved metallic trace elements concentrations ($\mu\text{g.L}^{-1}$) in PZ1 groundwater

Parameter	Al	As	B	Ba	Br	Cd	Cr	Cu	Fe	Li	Mn	Ni	Pb	Sb	Se	Sr	Zn	F
Average	6.48	0.13	30.5	20.3	47.9	0.82	0.79	2.85	13.4	2.77	2.04	1.02	0.27	0.06	1.95	214	4.02	168
Minimum	0.79	0.12	24.0	19.0	21.0	0.02	0.63	1.08	3.0	2.71	0.44	0.40	0.27	0.06	1.61	128	2.00	100
Maximum	21.0	0.14	34.0	23.0	79.3	2.00	1.00	5.46	44.0	2.83	5.10	2.00	0.27	0.06	2.00	240	12.80	216
Median	4.0	0.13	31.6	20.0	42.4	0.44	0.74	2.00	8.0	2.77	0.58	0.83	0.27	0.06	2.00	230	2.16	164
Number	11	7	7	7	5	11	8	9	9	2	9	9	6	8	8	8	6	13
Standard deviation	6.42	0.01	3.98	1.44	21.3	1.04	0.19	2.31	14.5	0.08	2.65	0.70	-	-	0.14	36.8	4.32	29.4

4.2.2 Bacterial biodiversity

The groundwater bacterial biodiversity was marked on the piezometers PZ1, PZ3 and PZ5 by $0.2 \mu\text{m}$ filtering of a 2 L water sample then, the microbial DNA was directly extracted from filters (FastDNA Spin Kit for Soil). These DNA were examined by molecular CE-SSCP fingerprint of a universal bacterial biomarker (fragment of the gene encoding 16S rRNA) of which each species has a specific version. DNA obtained profiles are complex (multiple peaks) and different for each piezometer (Fig. 8): this shows a rich bacterial biodiversity and a strong spatial heterogeneity of microbial communities. The groundwater endogenous bacterial diversity therefore varies considerably between sampling points.

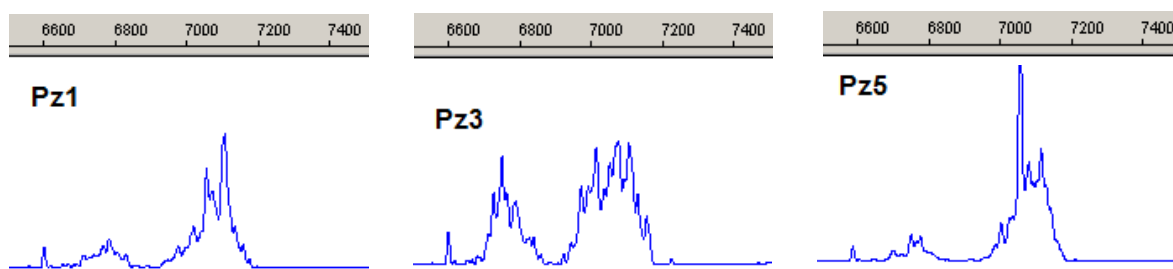

Fig. 8. Groundwater bacterial biodiversity profiles in the PZ1, PZ3 and PZ5 piezometers

4.3. Gas analysis

a) In the unsaturated zone

Measurements were made in piezairs to determine the composition of the underground atmosphere as a function of depth. The concentration logs showed a progressive CO₂ enrichment of the underground atmosphere with depth, accompanied by an O₂ depletion (Fig. 9a). The highest CO₂ concentrations vary in the different piezairs between 0.5% and nearly 2.5%, and the minimum O₂ levels are between 18% and 20%. A quasi stabilization of the gas mixture composition is systematically observed when depth exceeds 4-6 m. We observe a significant natural CO₂ background in the UZ that must be taken into account in the future monitoring of CO₂ leakage.

The time evolution monitoring of the gas in the UZ was started in March 2013. In all piezairs CO₂ is always found at levels higher than atmospheric level but with a concentration varying from a few thousands of ppm on a 12 hours cycle. The observed concentrations are between 1000 ppm (0.1%) and 25000 ppm (2.5%), typical for shallow soils. In all piezairs, the oxygen concentration varies simultaneously and oppositely to that of CO₂: the relationship between these two parameters follows the law of atmospheric O₂ replacement of by pedogenetic CO₂: this is a typical relationship of soil breathing involving CO₂ production by biological mechanisms.

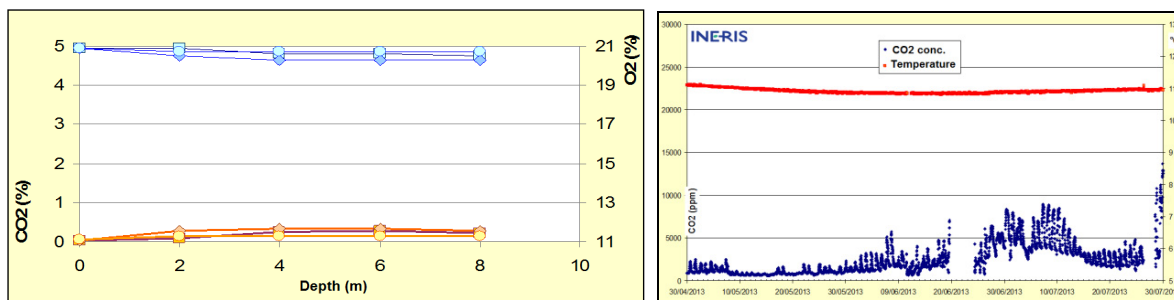

a) Gas logs(O₂ in blue, CO₂ in red)

b) Evolution of CO₂ and temperature

Fig. 9. Gas measurements in PA3 piezair (air well)

b) In the soils

Soil gases (CO₂, O₂, ²²²Rn) were measured in March, April, June and October 2013. In addition, a Barasol probe was implanted at one point, to record changes in the soil temperature, atmospheric pressure and radon concentrations.

As regards radon (Fig. 10), the site is relatively rich due to the presence of thanetian sands. The CO₂ being the carrier of this gas phase, the variations in radon concentrations are related to those seen in CO₂. In contrast to the behaviour of radon, O₂ concentrations vary inversely to that of CO₂ because of the effects of biological activity in soils.

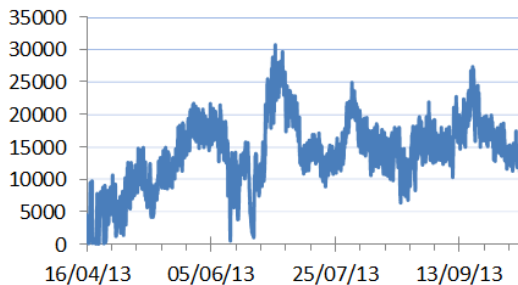

Fig. 10. Time evolution of radon concentration measurements (Bq.m⁻³) in the soil by Barasol probe

c) At the soil-atmosphere interface

The CO₂ flux measurements from the soil towards the surface were carried 12 times between late March and early October 2013. Inside the experimental site, the average flow is from 5 to 14 cm³.min⁻¹.m⁻² with a high variability (Fig. 11a). For points in the reference area, i.e. outside the *senso strictu* experimental site, the average CO₂ flux and its trend are similar to those obtained in the experimental site, but with lower variability (Fig. 11b).

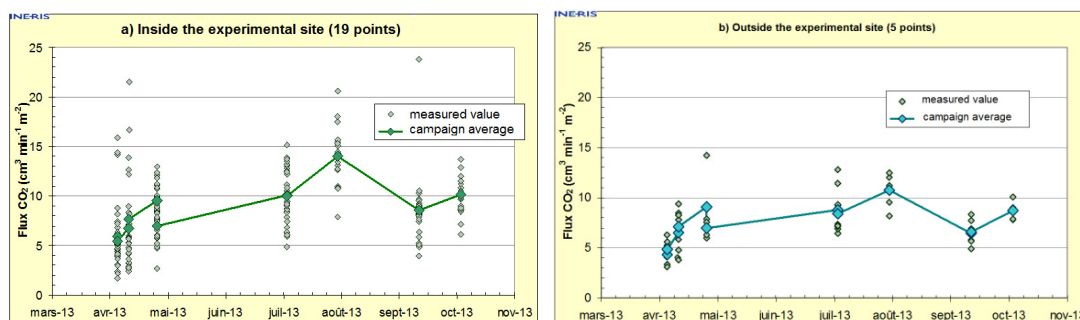

Fig. 11. CO₂ flux measurement at the soil-surface interface

5. Conclusion

The experimental site of Catenoy was instrumented in 2012 with an injection well, 9 piezometers, 5 “piezairs”, a weather station and a technical shed.

In 2013, characterization measurements were performed: pumping test, tracer test, logs, water, gas and rock analysis, CO₂ flux measurement from the soil towards the surface.

The site baseline, allowing the determination of the impact of future CO₂ injection, was mainly defined using data from the monitoring well PZ1 which is the upstream the injection well (PZ2).

The groundwater is a relatively homogeneous mass, at least as regards to the piezometers located near the future injection point. This homogeneity is fairly well imaged by the logs, although some lateral and vertical heterogeneities can be identified for certain parameters.

Based on these results, the proposed design for the CO₂ injection is:

- Injection volume: 10 m³ of CO₂ saturated water (i.e. ~20 kg of dissolved CO₂);
- Injection rate: ~ 5 L.min⁻¹ (with a peristaltic pump);
- Breakthrough period: 1-2 weeks.

References

- [1] Lions J. et al., 2014, Potential impacts of leakage from CO₂ geological storage on geochemical processes controlling fresh groundwater quality: a review, IJGGC, DOI 10.1016/j.ijggc.2013.12.019.
- [2] Gal et al., 2014, CO₂ leakage in a shallow aquifer – Observed changes in case of small release, submitted to GHGT-12.
- [3] Pokryszka Z, Charmoille A, Bentivegna G. Monitoring géochimique en phase gazeuse à la surface et dans la couverture intermédiaire des sites de stockage. Synthèse des travaux de l'INERIS. INERIS-DRS-08-71082-09108A, 2008 (http://www.ineris.fr/centredoc/ANR-Monit_RappFin_INERIS-DRS-08-71082-09108B.pdf)
- [4] Pokryszka Z, Charmoille A, Bentivegna G. Development of Methods for Gaseous Phase Geochemical Monitoring on the Surface and in the Intermediate Overburden Strata of Geological CO₂ Storage Sites. OGST, 2010, Vol. 65, No. 4, 653-666
- [5] Gal F, Gadalia A, 2011. Soil gas measurements around the most recent volcanic system of metropolitan France (lake Pavin, Massif Central). Comptes Rendus Geosciences 343 (2011) 43–54, DOI : 10.1016/j.crte.2010.11.008
- [6] French CR, Carr JJ, Dougherty EM, Eidson LAK, Reynolds JC, DeGrandpre MD. Spectrophotometric pH Measurements of Freshwater. Analytica Chimica Acta. 2002, 453:13–20.
- [7] Liu X, Wang ZA, Byrne RH, Kaltenbacher EA, Bernstein RE. Spectrophotometric Measurements of pH in-Situ: Laboratory and Field Evaluations of Instrumental Performance. Environmental Science and Technology. 2006, 40:5036–5044.
- [8] Gal F, Pokryszka Z, Lafortune S, Michel K. Surface and near surface geochemical surveying of a CO₂ injection pilot : application study to the French Pyrenean foreland (Rousse CCS pilot) Sustainable earth sciences (SES 2013), 30/09-04/10/2013, Pau.