



**HAL**  
open science

## Back-analysis of the rockburst in Frieda 5 and design program for panel in seam 6 (HBL-France)

Vincent Renaud, Lynda Driad, Marwan Al Heib, J.-F. Noirel

► **To cite this version:**

Vincent Renaud, Lynda Driad, Marwan Al Heib, J.-F. Noirel. Back-analysis of the rockburst in Frieda 5 and design program for panel in seam 6 (HBL-France). ROCKBURSTS International Symposium 2002, Nov 2002, Ustron, Poland. pp.313-326. ineris-00972385

**HAL Id: ineris-00972385**

**<https://ineris.hal.science/ineris-00972385>**

Submitted on 3 Apr 2014

**HAL** is a multi-disciplinary open access archive for the deposit and dissemination of scientific research documents, whether they are published or not. The documents may come from teaching and research institutions in France or abroad, or from public or private research centers.

L'archive ouverte pluridisciplinaire **HAL**, est destinée au dépôt et à la diffusion de documents scientifiques de niveau recherche, publiés ou non, émanant des établissements d'enseignement et de recherche français ou étrangers, des laboratoires publics ou privés.

## BACK-ANALYSIS OF THE ROCKBURST IN FRIEDA 5 AND DESIGN PROGRAM FOR PANEL IN SEAM 6 (HBL – FRANCE)

This paper develops the studies carried out after the fatal accident occurred during the mining of Frieda5-1250 panel at Merlebach mine section of HBL (East France). On the 21 June 2001, a violent rockburst (local magnitude of 3.6) has affected the panel 1250 of Frieda5 coal seam. An investigation program was carried out to determine the causes of this accident and to understand the induced phenomenon. The program include: seismic investigations, geological and geotechnical analysis and numerical modeling. The objective is to determine eventually the presence of particular geological structures and their role in the initiation of the accident. After the accident, the HBL intended to mine the Seam 6. In order to monitor the behavior of the ground during the mining of the Seam 6, a geotechnical program comprising a complete study of the natural conditions and a seismic analysis was carried out. The environment of the panel is marked by the presence certain number of faults. Stress disturbed by the exploitation of the old panels and the presence of faults are likely to modify the equilibrium of strata before the exploitation and can induced seismicity. To study their influence, the INERIS carried out a numerical modeling in the scale of mine area (SUIT3D and FAULT3D), for the determination of the stress zone induced by old and new panels.

### 1 INTRODUCTION AND OBJECTIVE

On June 21 2001, a fatal rock burst affected the main gate of the Frieda 5-1250 panel in the Merlebach Mine (HBL). The rock burst was extremely violent (magnitude 3.6). The heave exceeded 2 m (figures 1 and 2, HBL note number 384/01-JPA/ND [3]). The damaged zone was 250 m long and was located at between 100 m and 350 m in front of the face (between the sides).

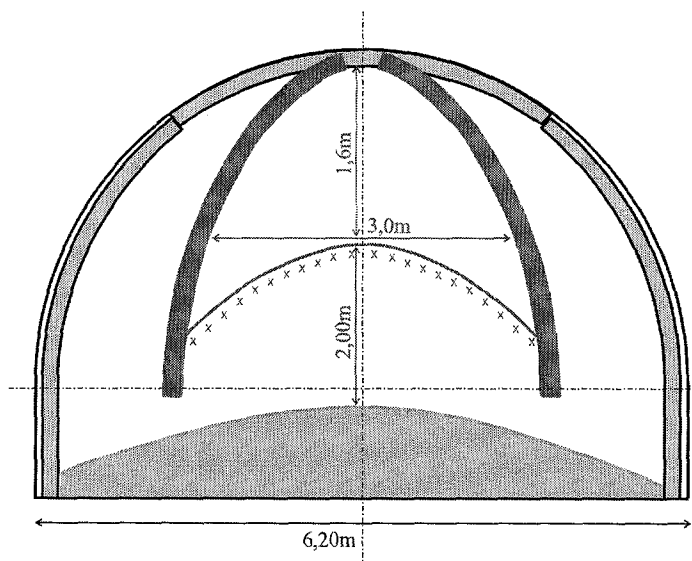

Fig. 1: Diagram showing bottom level blow off.

Based on prior knowledge, the accident zone was not considered to be subject to the risk of dynamic phenomena. Therefore, the mechanism causing this phenomenon had to be known so that a methodology for monitoring future panels could be defined. This methodology will assure safety in the mine with regard to the risk of dynamic phenomena. A search program was started up for this purpose, including the following aspects:

- a detailed geotechnical exploration: exploration boreholes, geomechanical tests and stress measurements;
- a series of numerical simulations at the scale of the entire deposit (using the SUIT3D software) and a model on a local scale (using the UDEC code [4]);

<sup>1</sup> Ph. D., Eng. – I.N.E.R.I.S. (France)

<sup>2</sup> Eng. – H.B.L. Coal Mine (France)

- a seismic and seismo-acoustic retro-analysis were carried out to understand the cause of the advance and the seismic activity that preceded and followed the event.

The results obtained were submitted to a college of international experts. Their opinions were used as a basis firstly to determine the causes of the accident in the Frieda 5 seam, and secondly on Seam 6 operations, then on the Dora seam.

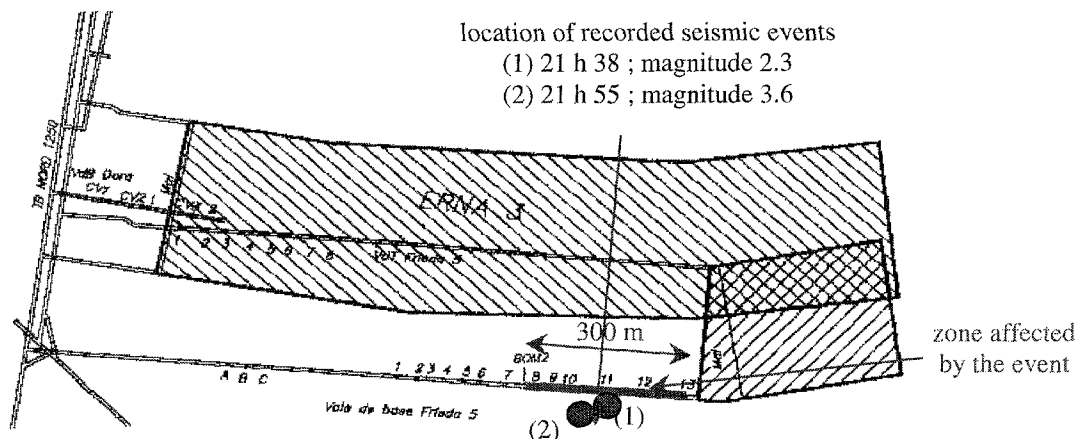

Fig. 2: View of the damaged zone and location of seismic events.

## 2 ANALYSIS OF THE FRIEDA 5 ROCK BURST

### 2.1 SEISMIC ANALYSIS OF THE FRIEDA 5 ACCIDENT

A detailed analysis of the seismic activity during this day was carried out to determine the location in space of the seismic focuses and the mechanism involved at the source.

#### 2.1.1 LOCATION OF THE SEISMIC EVENT

Seismic monitoring of mining operations at HBL is done using a listening network composed of about twelve recording stations on the surface and at the bottom of the mine [1, 7]. One of the important phases of the seismic analysis is to estimate the position of event focuses, determined from the source directions of the P waves (the first to arrive) recorded by the sensors.

The seismic focus of the 21/06/01 event is located on the Frieda5 main gate 100 m in front of the face (figure 1). The location in depth shows that the depth of the focus of this event is about 1400 m (estimated depth below the surface, figure 2) at 200 m from the Frieda5 cutting face.

#### 2.1.2 MECHANISM AT THE FOCUS

The rupture mechanism was identified starting from an interpretation of the direction of the first movement of the seismic wave from the event. The technique consists of positioning the direction of the first movement of the wave recorded by each sensor on a Schmidt geodetic reference network. This type of analysis determines the mechanism of the source that induced the event. Implosive mechanisms (total expansion) associated with rupture of the rock mass (for example block caving) are very frequently observed in coal mines. When fault type geological structures are involved, the resulting mechanism is shear (expansion + compression). It is possible that the mechanism is combined and therefore difficult to interpret, particularly when the seismic listening network is not sufficiently dense in terms of the number of recording stations.

In the case of the June 21 2001 event, the analysis of the direction of the first movement demonstrated an explosive rupture mechanism. More explicitly, the movement of the wave was a pure compression. Events recorded before the accident, and particularly the 21/06/2001 event at 19h 38 (~ 20 min before the accident), show a shear mechanism (figure 2).

A study was carried out on the history of the seismic activity at cutting faces located in the Frieda5 sector. This retro-analysis identified four events with a magnitude greater than 2.0 located exactly in the area of the accident. These events induced by operation of the Irma-1250 face in January 1999 were analyzed, considering the direction of the first movement of the wave. The identified rupture mechanism is explosive, and the same as the 21/06/01 mechanism associated with Frieda5 (figure 3). This observation shows that the anomaly in the accident area did exist, but was less active before Frieda5 was put into operation.

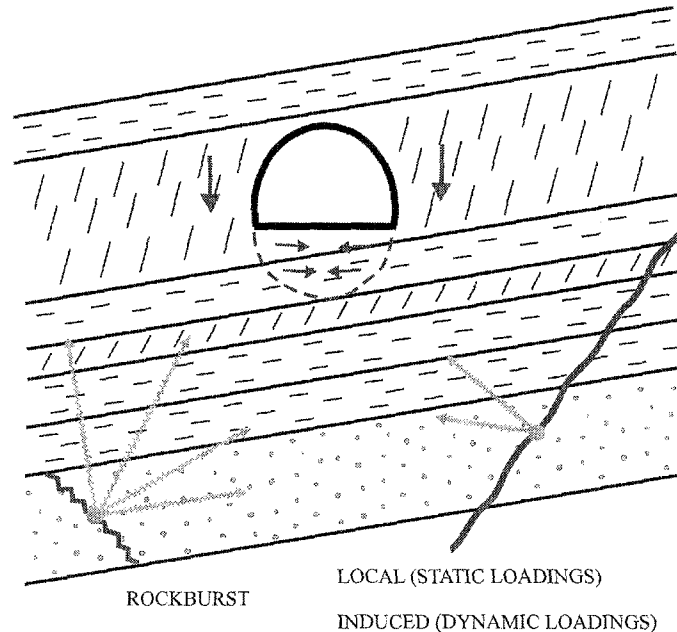

Fig. 3: The identified rupture mechanism

### 2.1.3 CONCLUSION

The conclusions of the seismic analysis of the 21/06/01 event that occurred during operation of the Frieda5 face are as follows:

1. the local magnitude of the recorded seismic event was 3.6, and it was located on the main gate of the Frieda5 face at a depth of about 1400 m;
2. the rupture mechanism involved is of the explosive type (total compression), this mechanism induced by a high horizontal stress agrees with field observations (heave);
3. the explosive rupture mechanism was observed in the same zone in 1999 during operation of the Irma-1250 cutting face;
4. the Frieda5 event is probably related to a local geological anomaly at about 25 m from the Frieda5 face (solid and very strong sandstone bed)

### 2.2 SUMMARY OF THE GEOTECHNICAL EXPLORATION

An analysis of the boreholes confirms that there is a relatively solid sandstone bed at the level face, starting from a depth of 23 to 24 m. Its thickness varies between 15 and 20 m. A very thin layer of schist passes through the middle.

An analysis of the fracture and particularly the RQD<sup>1</sup> shows that the sandstone bed is solid and that the value of the RQD is close to 100%.

<sup>1</sup> RQD : Rock Quality Design corresponding to the sum of the cores over a length exceeding 10 cm compared with the total length of the borehole

The geomechanical properties show that the coal analyzed at the Frieda 5 face is fairly strong. The sandstone is highly anisotropic. The Young's modulus of the sandstone in particular is not as high as Young's modulus for most sandstones tested in the HBL field [5].

Stress measurements show that horizontal stresses are very high and the vertical stress is less than the weight of the ground (figure 4).

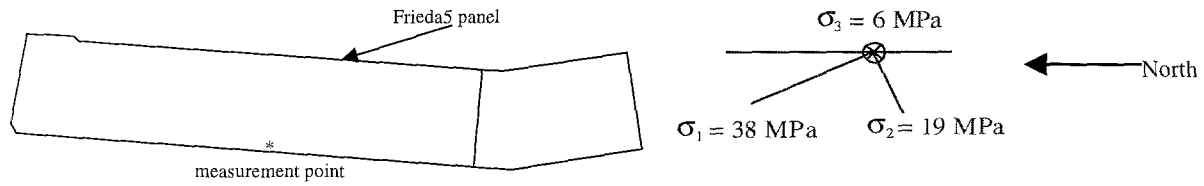

Fig. 4: Stress diagram in accident zone

### 2.3 ANALYSIS BASED ON NUMERICAL SIMULATIONS

In this complex configuration, the numerical model provided some elements of a response attempting to reproduce the physical mechanism responsible for this accident. Two model types were made, one at large scale and the other at local scale (the main gate).

#### 2.3.1 LARGE SCALE MODEL

The model using the SUIT3D program ([8], figure 5) was intended to achieve two objectives, firstly to find the initial tensor before mining started, and variations in the stress tensor close to the area of the accident [2]. The calculation was made assuming linear elasticity, with an isotropic stress tensor over the scale of the deposit. The seams considered in the calculation are shown in table 1.

Seam	Distance/Frieda5-1250	Number of panels
Louise	324 m	3
Irma	100 m	2
Georgette	50 m	2
Frieda5	0 m	1 + final advance
Erna3	-70 m	2

Table 1: Characteristics of modeled seams

Based on these assumptions, the results obtained were as follows:

- mining operations in the Irma-1250 panel considerably modified the distribution of normal, horizontal and axial stresses. The influence of Erna3 and Frieda5 operations is lower and never exceeds 20%;
- overstress areas correspond to the Louise TB zone and the zone ahead of the Irma-1250 face;
- in the intermediate zone (where the part of the Frieda5-1250 panel on which mining operations are taking place is located, and the part of the bottom level affected during the accident); the vertical stress in these zones is relieved;
- furthermore, the influence of mining operations in the Frieda5-1250 panel is limited to zones close to the part of the panel from which coal has been extracted, and in particular it appears weak in the part of the level affected by the accident.



Fig. 5: Modeled seams with SUIT3D

### 2.3.2 MODEL AT THE SCALE OF THE MAIN GATE

Two models were made. One was for a vertical cut perpendicular to the center line of the gate. It is loaded by the stress condition measured at 800 elevation. The other model is a transverse model. The first model did not produce any results that could explain the origin of the rockburst.

The second model corresponds to a north south section and only includes the level face. The considerable extent of the level face implied a prior mechanism consisting of a long beam in bending built at its ends by zones with vertical overstresses.

The geometry of the model is built up using boreholes results made by HBL, at 50 m from the zone affected by the rock burst. Loads applied to the model were determined using the SUIT3D code, we have a stress field demonstrating the situation before the accident for the entire Frieda 5-1250 panel (figure 3);

A parametric analysis was carried out to simulate the bench bending mechanism, to find cases and sub-cases dependent on eight geometric and mechanical factors [6].

The results of this model determined operating and environmental conditions to reproduce the rockburst. These conditions are illustrated in figure 4 and are summarized below:

- 1) a bottom case with a variable thickness sandstone bed (between 0 m and 20 m) and a 125 m wide zone in which vertical stresses were relieved;
- 2) a bottom case mode with N-S horizontal stresses increased by 25 %;
- 3) same mode as above (case 2) but with the Frieda 5 face advanced by 400 m, which is close to the accident configuration.

The mechanism studied would appear to be capable of reproducing total deconsolidation of the bed under some conditions (figure 6):

- the vertical stress relief in the accident zone must be less than or equal to 4 MPa;
- the North-South horizontal stresses must be high (higher than 60 MPa and therefore higher than the measurements made in situ);
- East-West horizontal stresses, and particularly shear stresses, are design parameters that are less sensitive than the previous two;
- the compression strength ( $R_c$ ) of the sandstone bed had to be halved so that the second sandstone bench could be fractured.

This fourth condition would imply heterogeneous mechanical properties of the sandstone bed (particularly the compression strength).

Furthermore, the results of this study show that as the Frieda5 face advances, the risk of the bed fracturing in the accident zone increases.

Furthermore, the length of this stress reduction zone also has an influence on the results; if the length of the pressure relief zone at 4 MPa decreases from 125 m to 80 m, the number of plastic points reduces by 30 %.

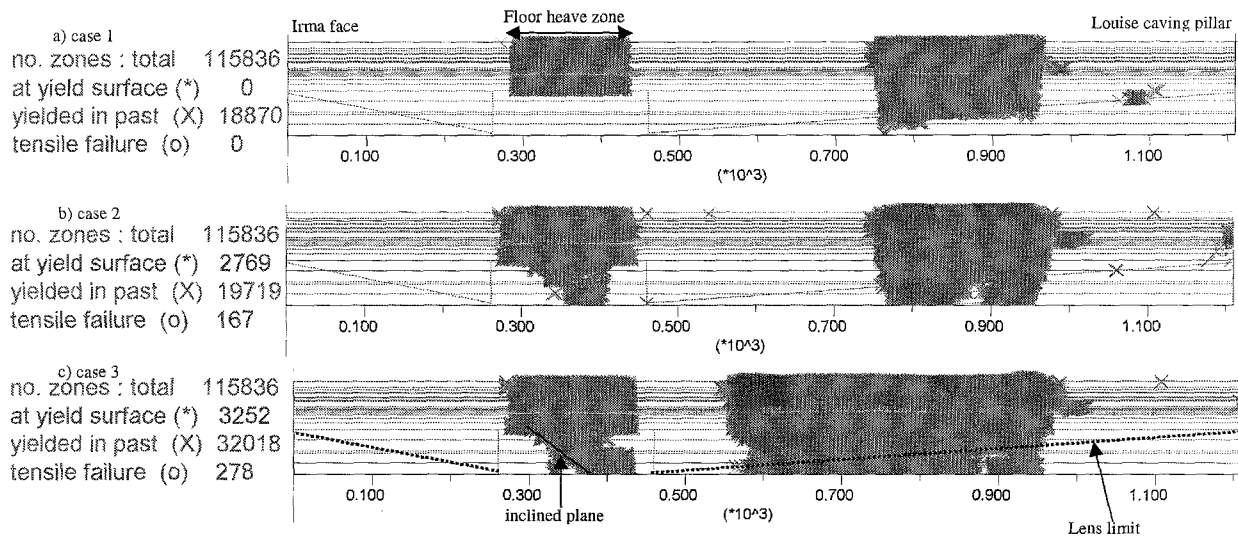

Fig. 6: Overview: distribution of plasticity

Case 1: 200 m advance

Case 2: 200 m advance, effect of the axial horizontal stress

Case 3: 400 m advance, effect of stress gradients

### 3 PLANNING AND MONITORING OF OPERATIONS OF THE PANEL IN SEAM 6

A geotechnical program was carried out including a complete study of natural conditions, in order to predict the behavior of the ground during operation of panel 1140-1250 in Merlebach mine Seam 6. It is divided into three parts:

- a geological and geotechnical exploration of the future operated zone;
- a large scale numerical model;
- an analysis of the seismicity induced in Seams 1 and 2 and the size of the future seismoacoustic monitoring network.

The total length of the panel is 400 meters and the width of the cutting face is 260 meters.

### 3.1 GEOLOGY AND ENVIRONMENT OF THE PANEL

Seam 6 is located in the Cocheren North field, which is a series of Lower Coal Group. Boreholes made show that the roof and the walls are composed of beds of sandy schist and sandstone beds. These sandstone beds are usually associated with fine carbonaceous inclusions. According to boreholes observations, there is a sandstone bed, at least 15 m thick at the Seam 8 wall. Note that there is no diskings in any of the boreholes.

The RQD values suggest that the roof is not as sound and more fractured than the face of Seam 6. Above the seam, note the presence of Seam 5 that is 10 m above seam 6, and the presence of seam 8 above the face at depth about 12 m.

The face of seam 6 is different and almost homogeneous along the main and tail gates. Unlike the Frieda5 seam, for which the face is composed of alternating coal and schist seams overlying a 20 m thick sandstone bed.

Stress measurements confirm stress reduction in Seams 1 and 2, horizontal stresses are strongly anisotropic and their ratio is greater than 3.

The panel is surrounded by four faults including the St. Nicolas fault which is by far the most important fault, but is furthest from the panel (figure 5).

### 3.2 LARGE SCALE NUMERICAL MODEL

We made a numerical model at the scale of the Cocheren North field to determine stresses in the operations zone and the influence of previous operations using the SUIT3D code on the tracks and also to study the influence of operations on the faults that surround the future panel using the FAULT3D program.

The advance of the panel between 200 m and 470 m (maximum length) is simulated in 12 steps (figure 5). The model includes all mined panels of the Reumaux Mines (HBL).

The load on the full scale model was derived from:

- a vertical stress equal to the weight of the ground, namely  $(1250 \text{ m} \times 0.025 \text{ MN/m}^3 = 31 \text{ MPa})$  ;
- an east-west horizontal stress equal to 0.43 times the vertical stress (equal to 13.5 MPa) ;
- a north-south horizontal stress equal to 1.3 times the vertical stress (namely 40 MPa).

The results were analyzed considering the variation of the state of stress with the advance of panel 1140-1250 (figure 5). The comments can be made on this model:

- operation of the Seam 6 panel will have an influence ahead of the faces of the Seam 1 and 2 panels starting from an advance of 325 m. This is a very small modification compared with the initial state before operation of the panel;
- starting from 400 m, the influence becomes more significant. It corresponds to an increase in the normal stress (zones close to the roof track increase by 2 MPa, the 28 MPa contours move by 110 m ahead of the face on the bottom level) and an increase in the east-west horizontal stress at the face of the 1st panel in Seam 1 (increase of 2 MPa);
- in the ventilation zone, the greatest increase concerns the east-west horizontal stress, which is 15% of the initial value. The normal stress only increases by 5%. No modification is observed for the north-south horizontal stress;
- the front ends of Seams 1, 2 and 6 do not intersect until the advance reaches 450 m (the planned length).

Monitoring measurements (deformation measurements) were reinforced starting from a 400 m advance.



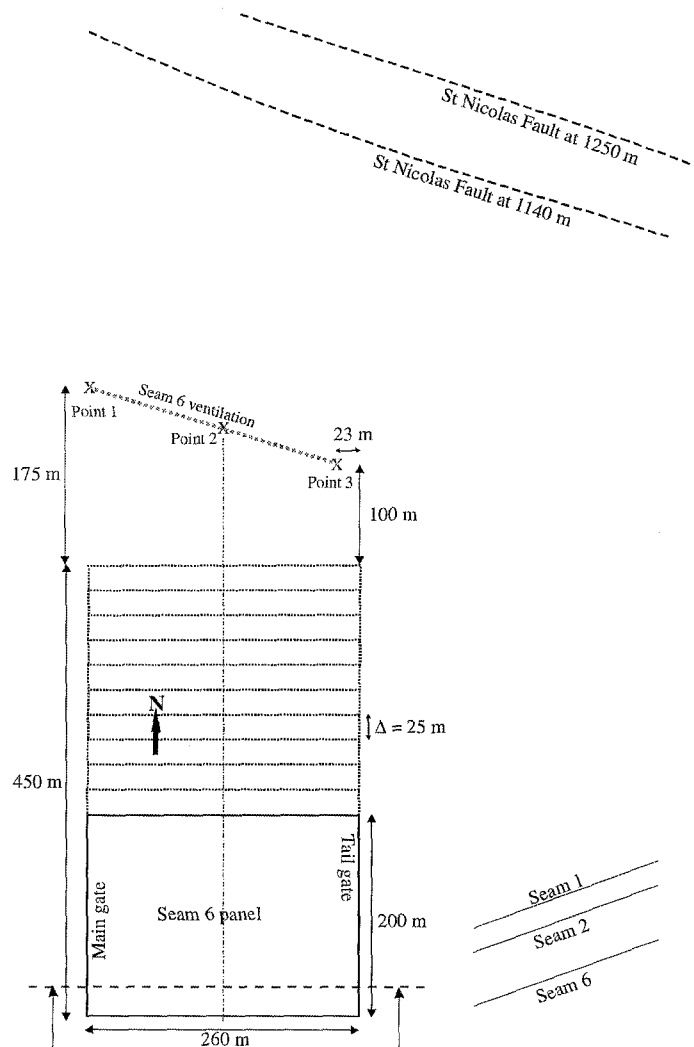

Fig. 5: Different steps in modeling the advance on the Seam 6 panel.

### 3.3 HISTORY OF SEISMIC ACTIVITY IN THE SECTOR OF THE CUT IN SEAM 6

A study of the history of seismic activity in the sector of the Cocheren North field was carried out as part of the prevention plan for the cut on Seam 6-1250. In particular, we considered the history of seismic activity related to the operation of the cuts closest to Seam 6. These are Seam 1 (panels 1140 and 1250) and Seam 2 (panel 1140).

#### 3.3.1 MINING PERIOD AND SEISMIC ACTIVITY

Seams 1 and 2 are located in the Cocheren North field, which is part of the Lower series in Merlebach mine. The Seam 6-1250 front is 120 and 100 m above Seams 1 and 2 respectively. Mining operations in this sector began on seam 1-1140 in 1995 and terminated at Seam 1-1250 in February 2001. Eight other cuts were operated in the Upper Coal series during this same period.

Seismic activity related to all mining operations carried out between 1995-2001 is represented by the spatial distribution of focuses of events recorded in the HBL regional listening network. Based on the distribution of focuses in the zone limited to Seams 1 (panels 1140, 1250) and 2 (panel 1250), it is quite obvious that seismic activity is much lower (209 events) than was observed in the West sector (Irma, Erna and Frieda, 1500 events). A distinction is made between three activity distributions (figure 6):

1. minor rock bursts, most with a magnitude of less than 1.5, related to ruptures close to the St Nicolas fault;
2. a cluster of focuses located at about a hundred meters to the East of the panels in the preferred NS direction. A single rock burst with a magnitude of more than 2 is identified;

- throughout the entire sector, only two rock bursts with a magnitude equal to 2.7 have been recorded and were located in the Seam 1-1250 panel.

To determine the mechanism, we considered all events with a magnitude of more than 2.0 recorded during mining panels in the Lower Gas Coal series.

In general, the mechanism identified in this sector is a shear failure of the fault type structure.

The results of the historic study on the seismic activity of Seams 1 and 2 (panels 1140, 1250) may be summarized as follows:

- the seismic activity related to mining operations on Seams 1 and 2 is particularly weak compared with the activity in the sector of the Frieda5 cut;
- only 7 of the 209 recorded events have a magnitude of more than 2.0.
- identified mechanisms at the focus associate these events with shear type failures.

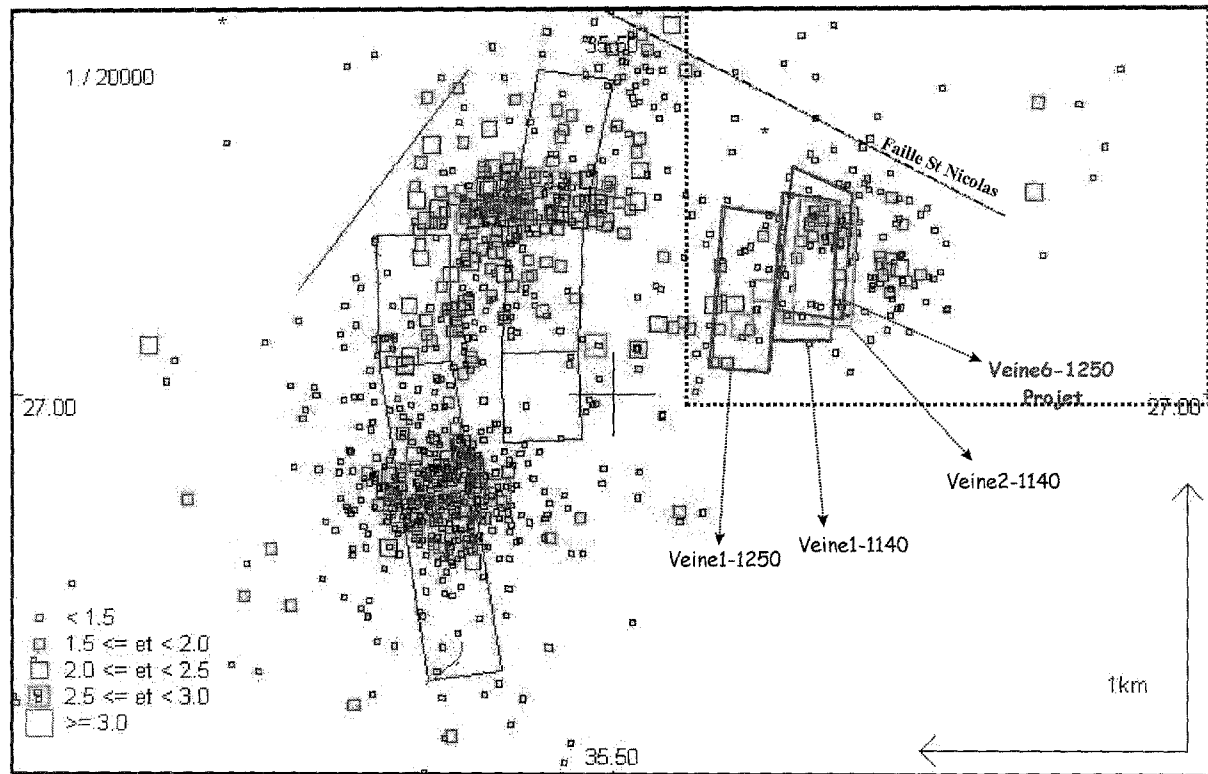

Fig. 6: Seismic activity of Seams 1 sector (1140, 1250 panels), Seam 2 (1140 panel), 1995-2001 period

### 3.4 SEISMIC ACTIVITY IN SEAM 6

Mining operations at the front on Seam 6 took place between October and March 2002. Seismic monitoring was done using regional and local networks (seismoacoustic). The seismoacoustic network is composed of high frequency jugs (14 Hz), and monitors operations on the scale of the front.

The seismic activity related to mining operations of Seam 6 was very weak ; The regional monitoring network did not record any rock bursts that could be assigned to the front. The number of events recorded in the seismoacoustic activity is greater, but the events are low energy.

Figure 7 shows curves of the energy dissipated during operation of the Irma-1250, Frieda5-1250 and Seam 6 fronts as a function of the advance. For the three fronts, the energy is calculated starting from the seismoacoustic data. Irma-1250 was exploited over the longest length (1300 m), and advance of the Frieda5 and Seam 6 fronts was 300 m and 444 m, respectively. Thus, a comparison can be made between the three energy variation curves for an advance of up to 444 meters. An analysis of the three curves shown in figure 6 shows that the energy level released by the Frieda5 front is the highest and that the relief speed increases quickly after 180 m advance. For the Irma-1250 front, the dissipated energy is low until 420 m and then increases gradually. Note that the energy released by the front in Seam 6 is the lowest throughout the entire mining operation period.

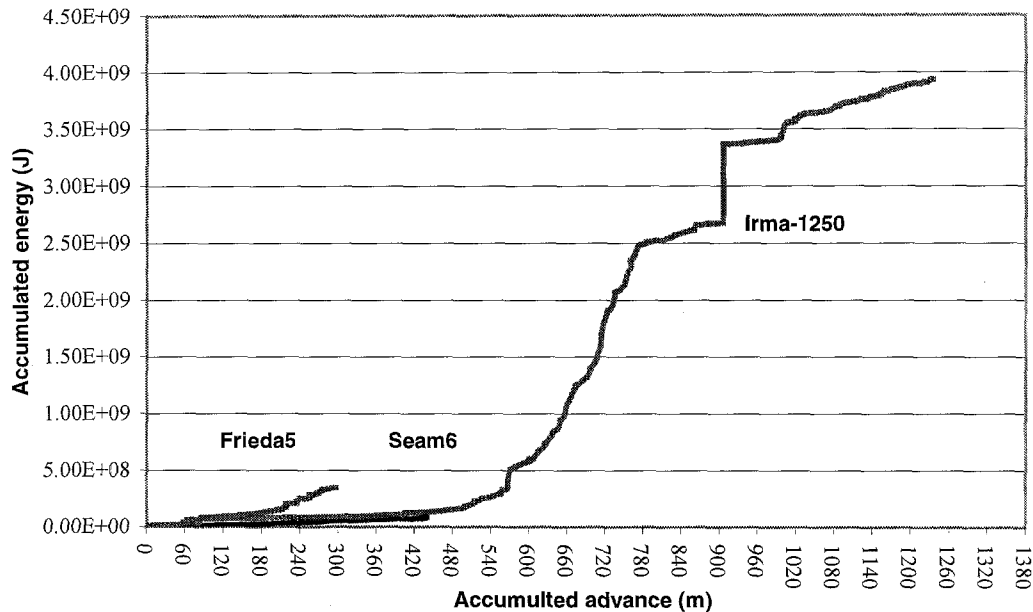

Fig. 7: Curves of energy dissipated during mining operations of the Frieda5, Seam6 and Irma-1250 cuts

## 4 CONCLUSIONS

After carrying out the analysis of the accident in the Frieda 5 seam (1140-1250), we introduced a new monitoring method in the Seam 6 panel (1140-1250). It was observed that seismicity was very low, and that the precautions taken did not cause any nuisance.

The same approach was used for the Dora seam.

The conclusion in this case was also favorable, and a monitoring and prevention plan was defined.

Experience with the previous panel suggests that the measures that we impose on ourselves will not have any significant repercussions on operation of the mine.

## LITERATURE

[1] ABDUL WAHED M. K. (2001): *Etude de la microsismicité induite à partir des sismogrammes tridirectionnels*. Thèse de doctorat, Institut National Polytechnique de Lorraine, Laboratoire de Mécanique des Terrains, Ecole des Mines de Nancy, 176 p.

[2] AL HEIB (1993): *Les nouvelles méthodes de modélisations numériques et le volume d'influence des exploitations minières en conditions complexes*, thèse de doctorat de l'INPL.

[3] AMARTIN J.-P (2001): « *CREEP* » - *Frieda 5 bottom track, June 21 2001 – 21 h 55*, HBL note No. 384/01-JPA/ND.

[4] ITASCA (2000): *UDEC 3.01 User's Guide and Command Reference*. Itasca Consulting Group Inc. Minneapolis, USA.

[5] MERY C. (1998): *Synthesis of the geomechanical characterizations*, INERIS report SSE-CMe/ATh-98-25EP51

[6] RENAUD V. (2001): *Attempted retro-analysis on the creep that occurred on June 21 2001 at the bottom level of the Frieda 5-1250 panel*, INERIS report DRS-01-20438/RN11

[7] SENFAUTE G. (1995): *La surveillance micro sismique de l'exploitation souterraine du charbon aux Houillères de Provence*. Thèse de doctorat, Institut National Polytechnique de Lorraine, Laboratoire de Mécanique des Terrains, Ecole des Mines de Nancy, 321 p.

[8] SYLLA M. (2001): *Modélisation numérique des exploitations minières par la méthode des éléments frontières développements et applications*. Thèse de doctorat, Institut National Polytechnique de Lorraine, Laboratoire de Mécanique des Terrains, Ecole des Mines de Nancy.